

POSITIONNEMENT DU GABARIT
ARTICLE N°GAB-E-0007770 & GAB-E-0007773

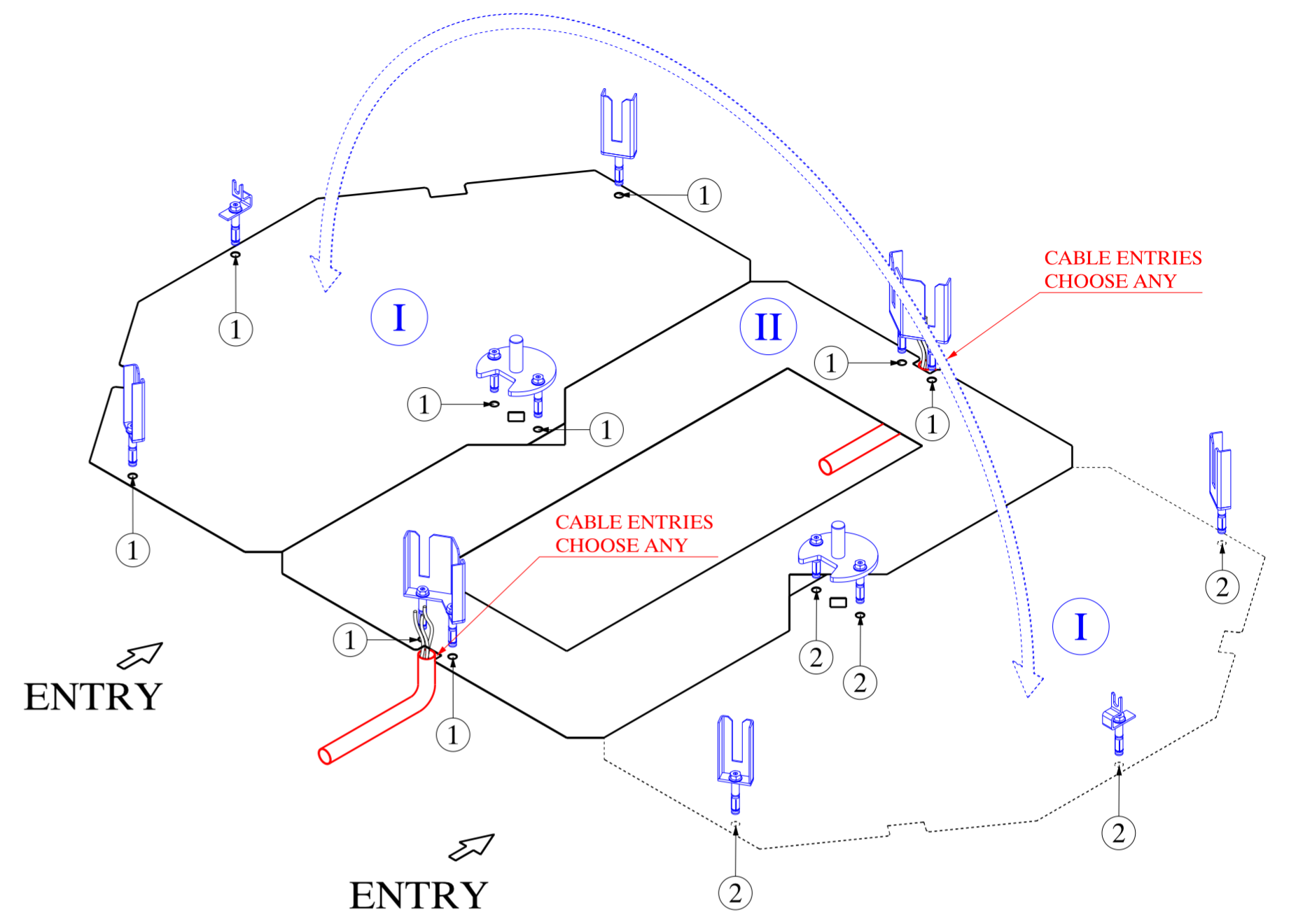

A-A' SECTION

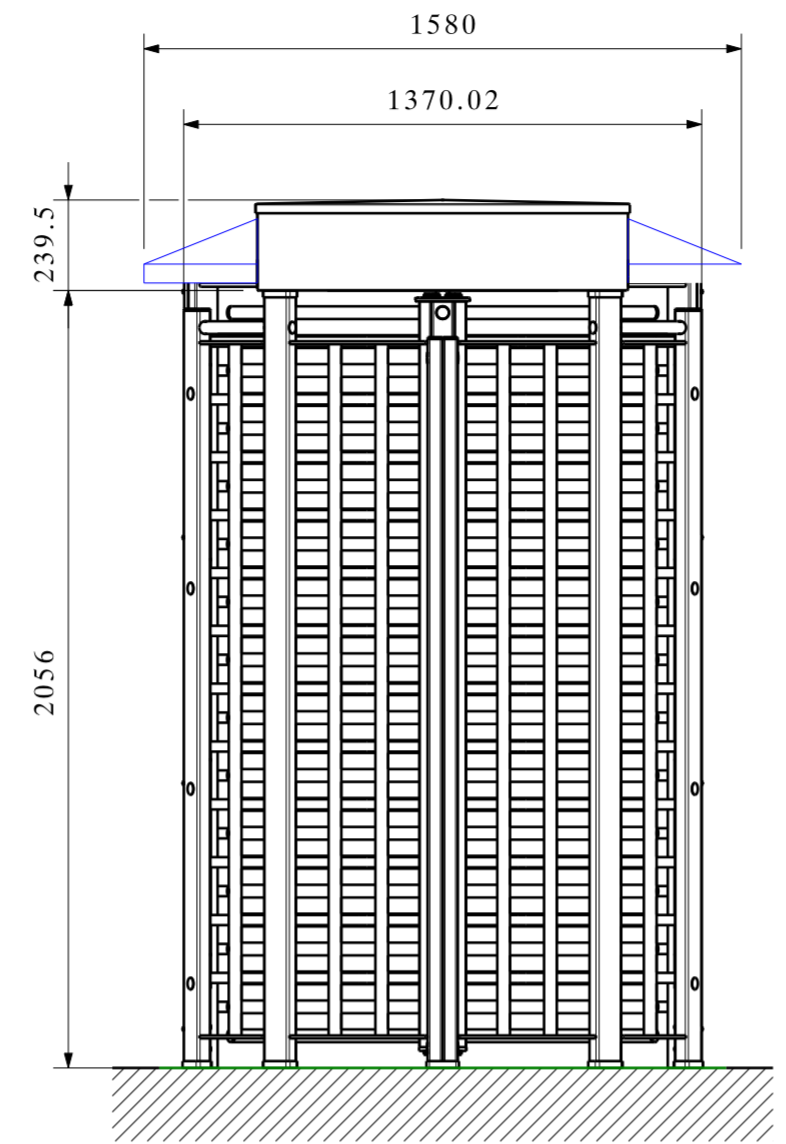
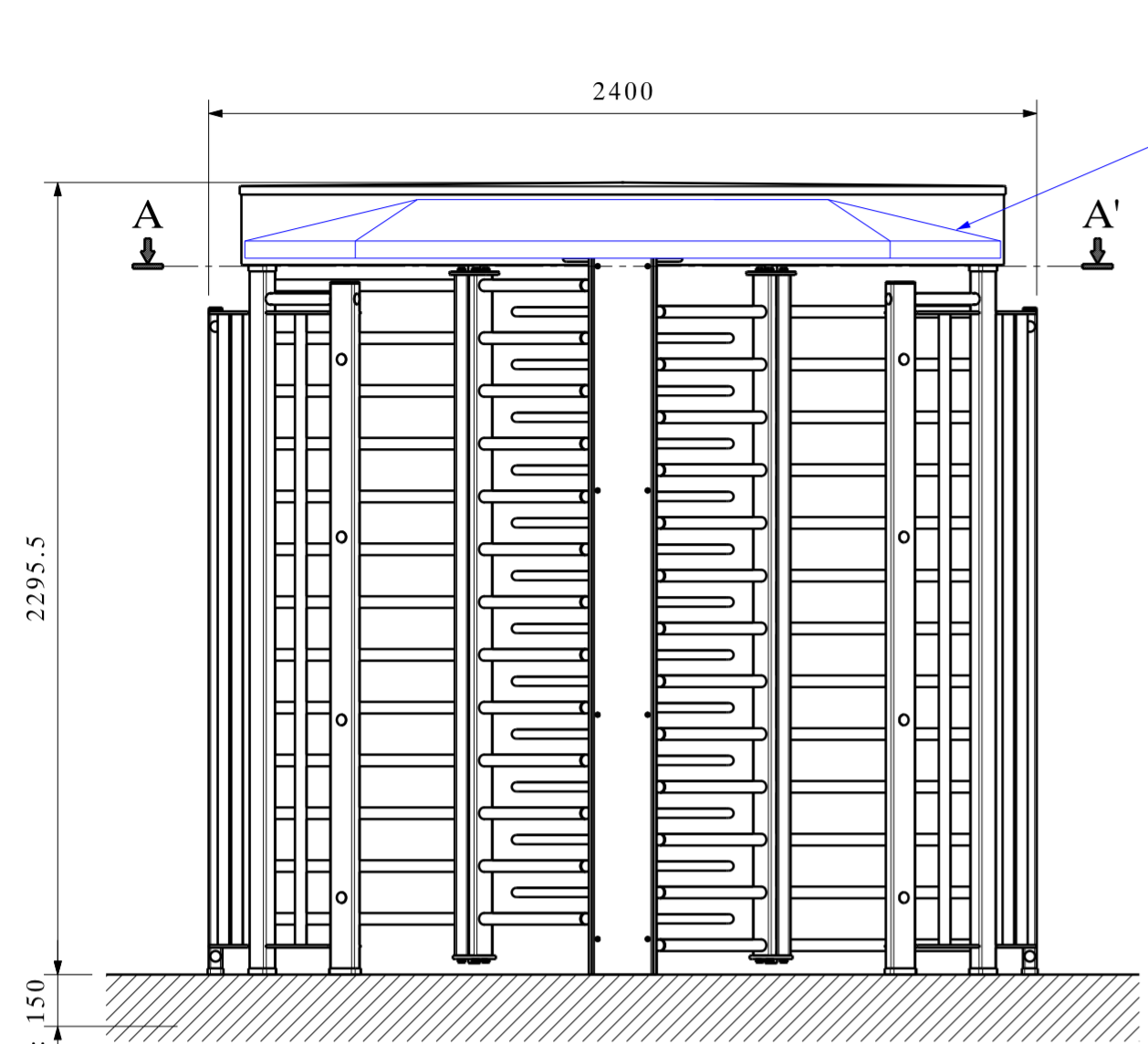
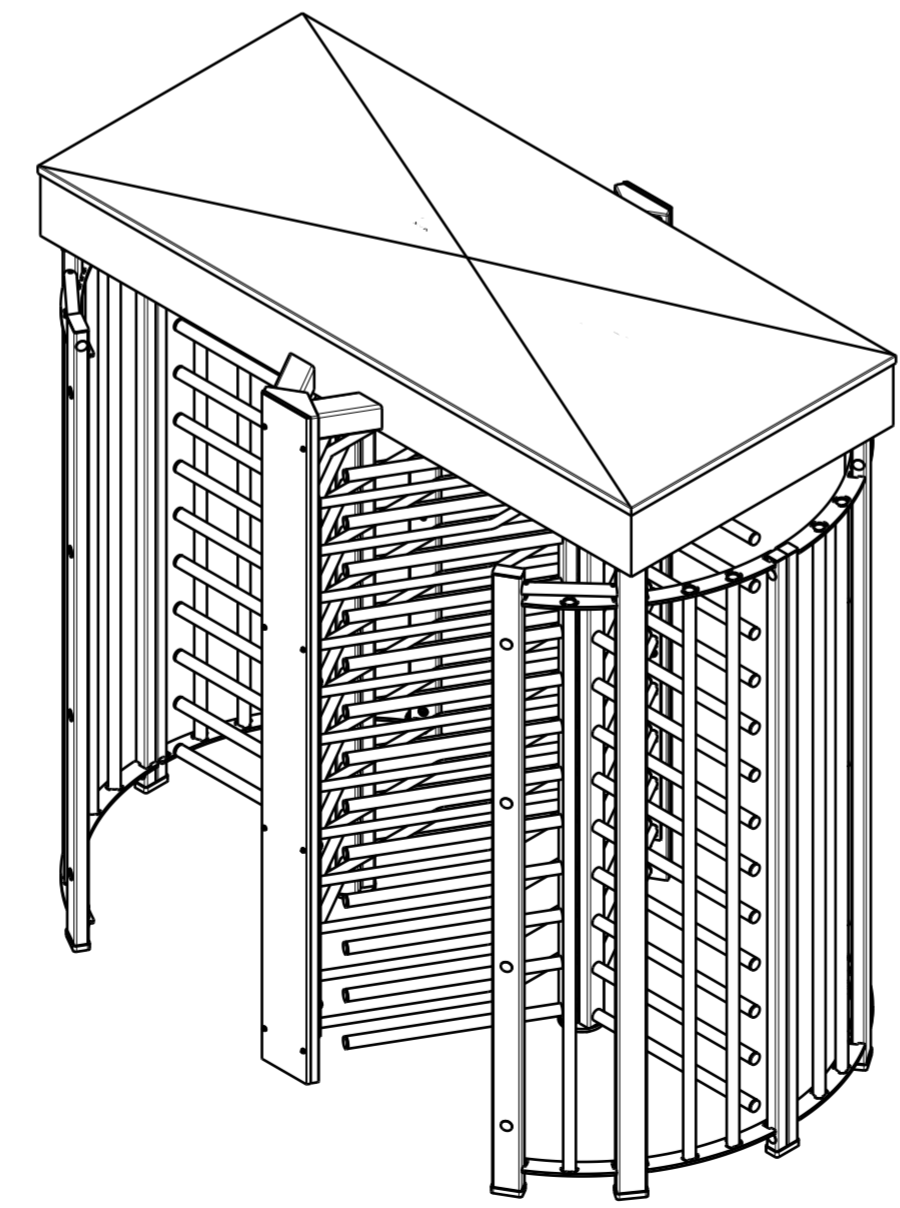
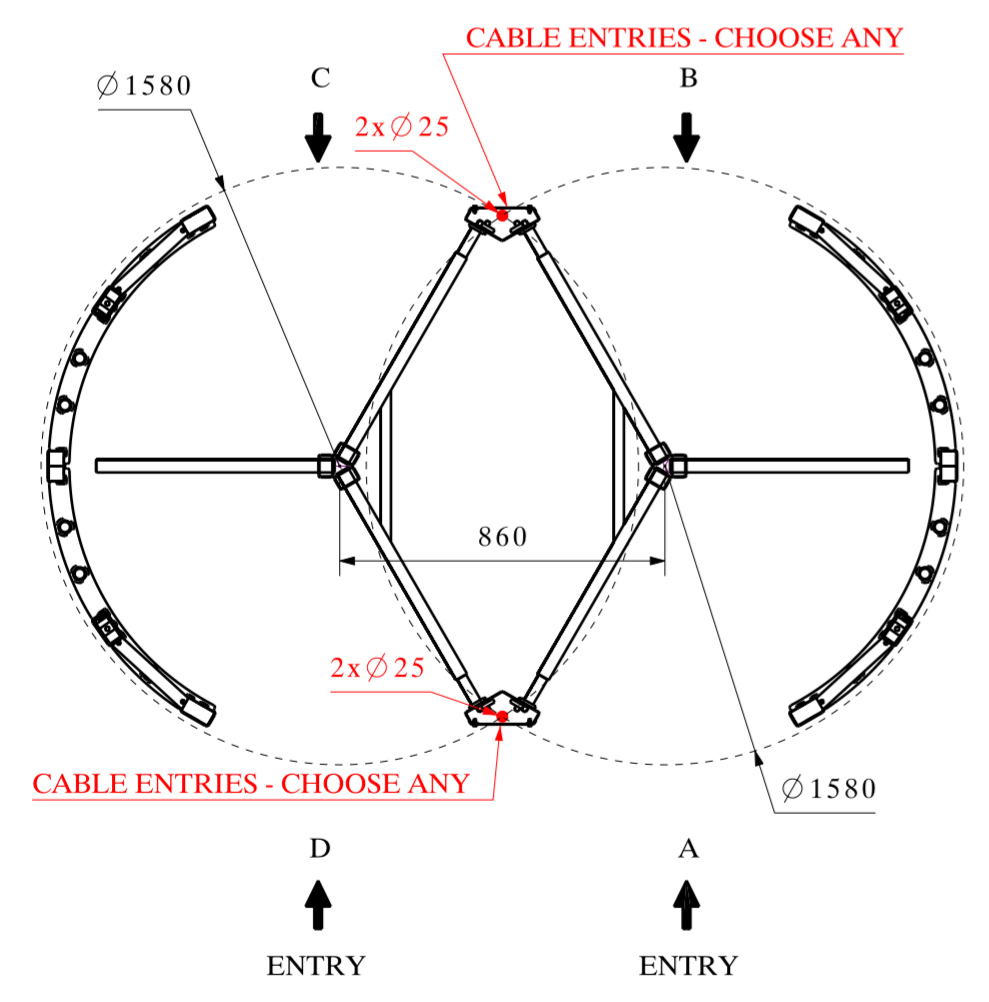

- Position templates I & II with regard to the entry direction
- 2 cables entry points are available on template II (max. Ø25mm)
- Mark points 1
- Rotate the template I
- Mark points 2

Les dimensions sont données en mm.
De afmetingen zijn gegeven in mm.
Ne pas mesurer sur le plan.
Niet meten op het plan.

| | | | | | |
|---|---------------------------------------|-------------------------|-----------------------|------------------------------|----------|
| Ce plan est notre propriété et ne peut être cédé à des tiers ni être recopié sans autorisation écrite de Automatic Systems. Dit plan blijft onze eigendom en mag niet voorgelegd aan derden noch worden gekopieerd zonder schriftelijke toelating van Automatic Systems. | | | | | |
| A | ARRIVE DE CABLE Ø50-->2xØ25 | CF | 07/10/2011 | | |
| INDICE : AANWIJZING : | MODIFICATIONS : WIJZIGINGEN : | PAR : DOOR : | DATE : DATUM : | | |
| TRS372 - INSTALLATION WITH TEMPLATE | | | | | |
| CLIENT : KLANT : | | | | | |
|  Avenue Mercator. 5 - B-1300 Wavre www.automatic-systems.com | | DESSINE : GETEKEND : | DATE : DATUM : | N° DOSSIER : N° DOSSIER : | |
| | | CF | 18/12/2007 | ----- | |
| | | VERIFIE : NAGEZIEN : | ECHELLE : SCHAAL : | PLAN N° : PLAN N° : | |
| | | FM | 1/20 | CH6762-gb | A |

POWER SUPPLY : Single phase 230V + ground with 3G2.5² mm (Type: XFVB recommended)
Control cable Type TPVF ou LiYCY

PVC tube 2xØ25mm for cables

WARNING: If control cables are not of TPVF or LiYCY type foresee a supplementary tube to separate power supply from control cables

ALL CABLES TO BE SUPPLIED WITH A MINIMUM 3 METRE FREE TAIL

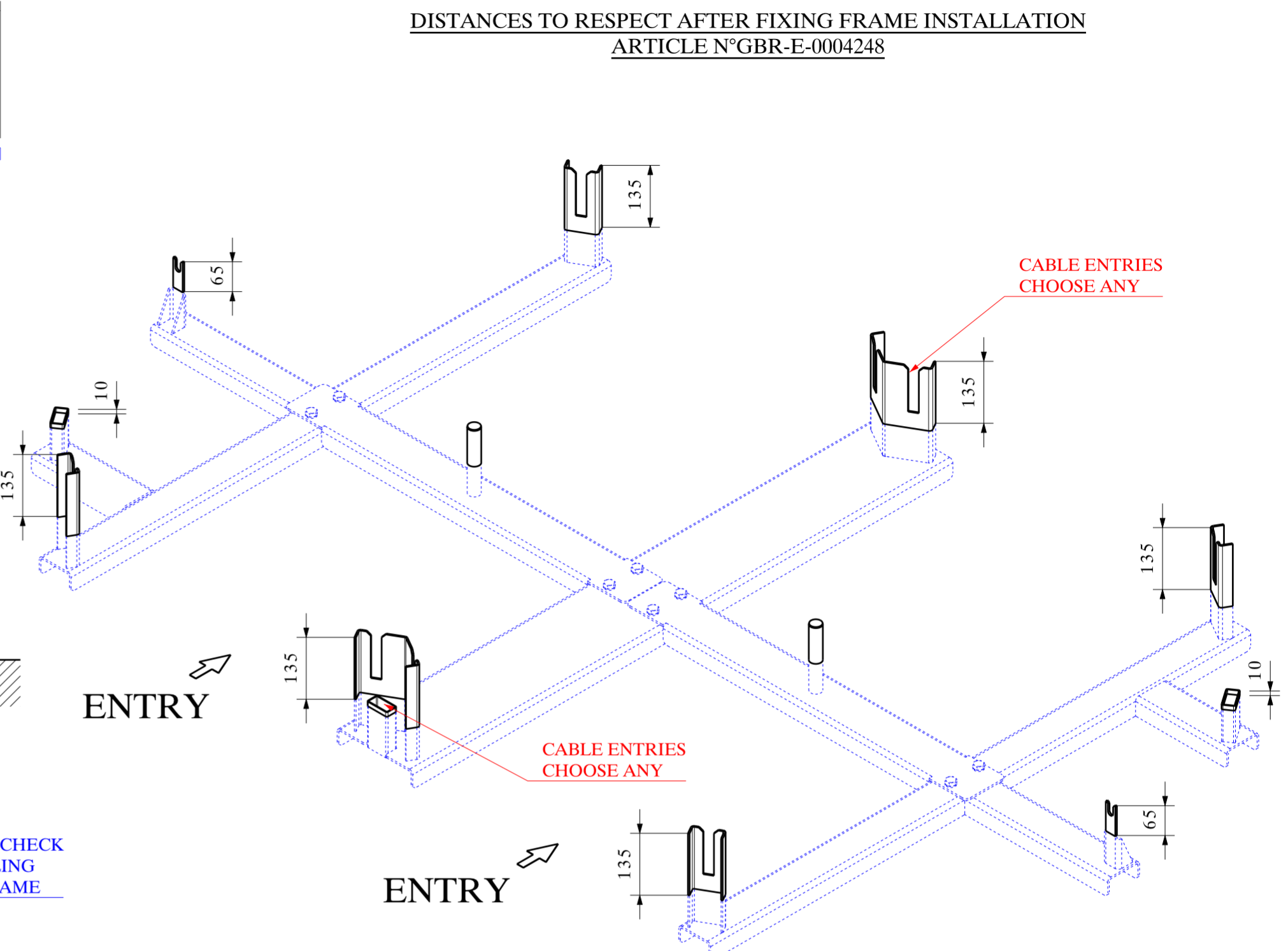
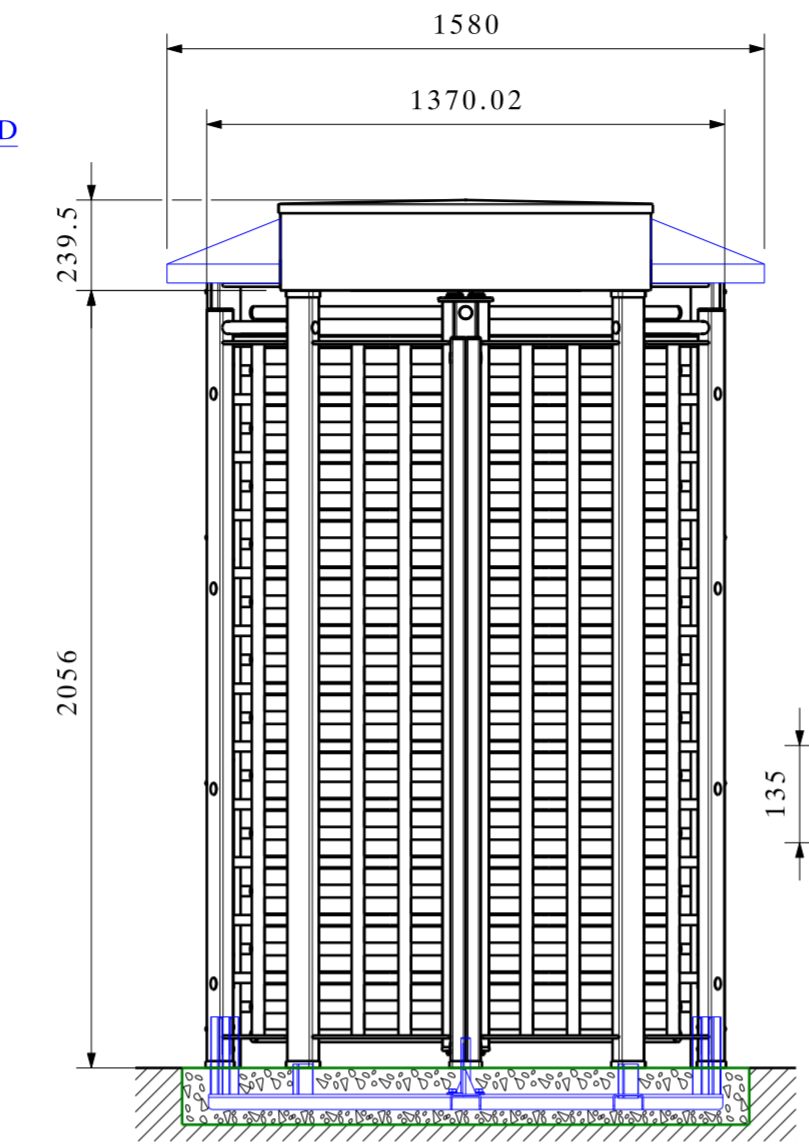
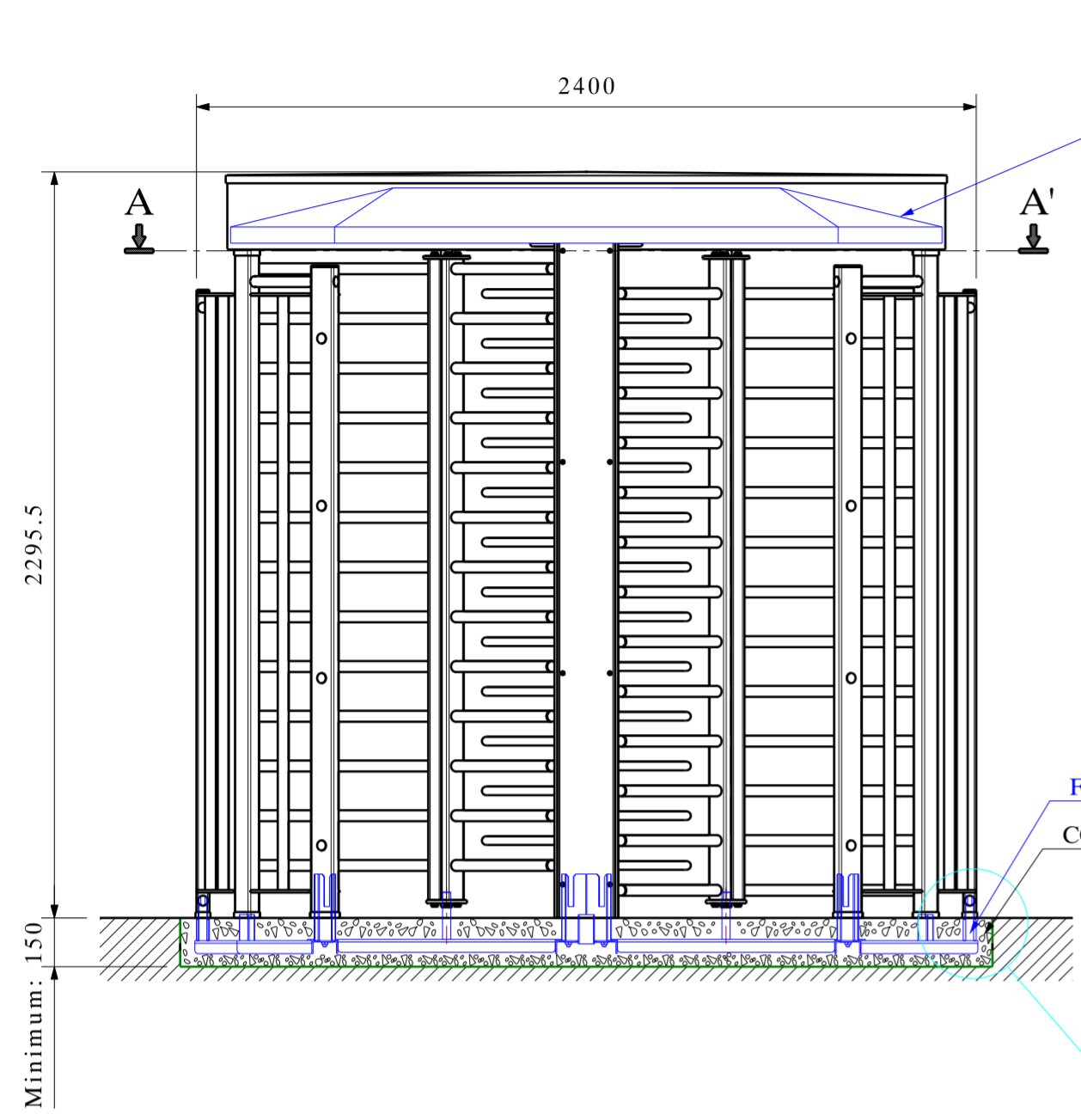

DISTANCES TO RESPECT AFTER FIXING FRAME INSTALLATION
ARTICLE N°GBR-E-0004248

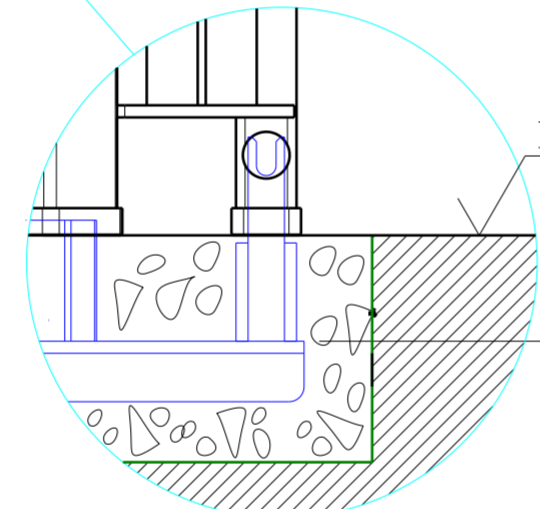

DISTANCES TO CHECK
WHEN INSTALLING
THE FIXING FRAME

COUPE A-A'

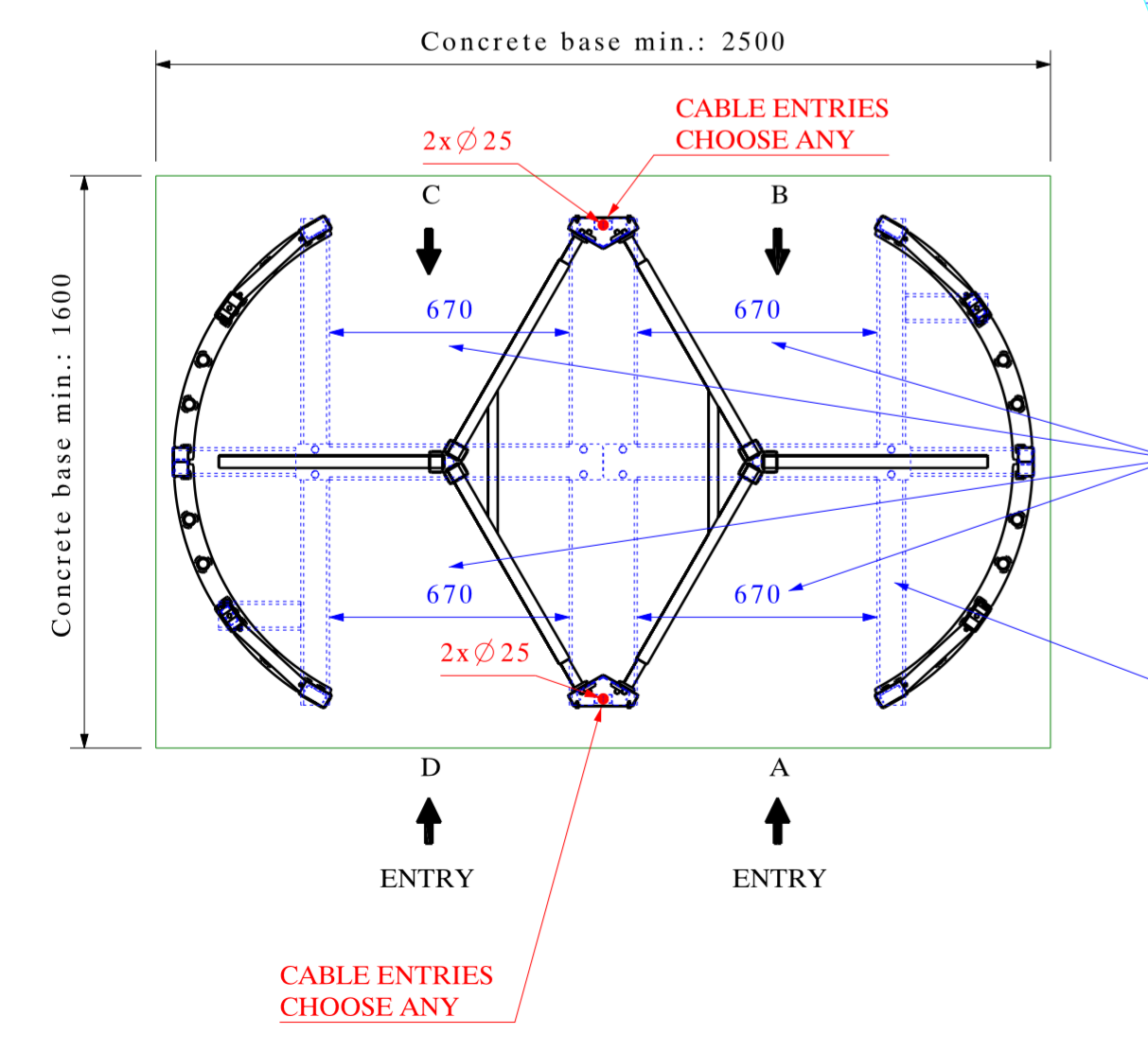

DISTANCES TO CHECK
WHEN ASSEMBLING
THE FIXING FRAME

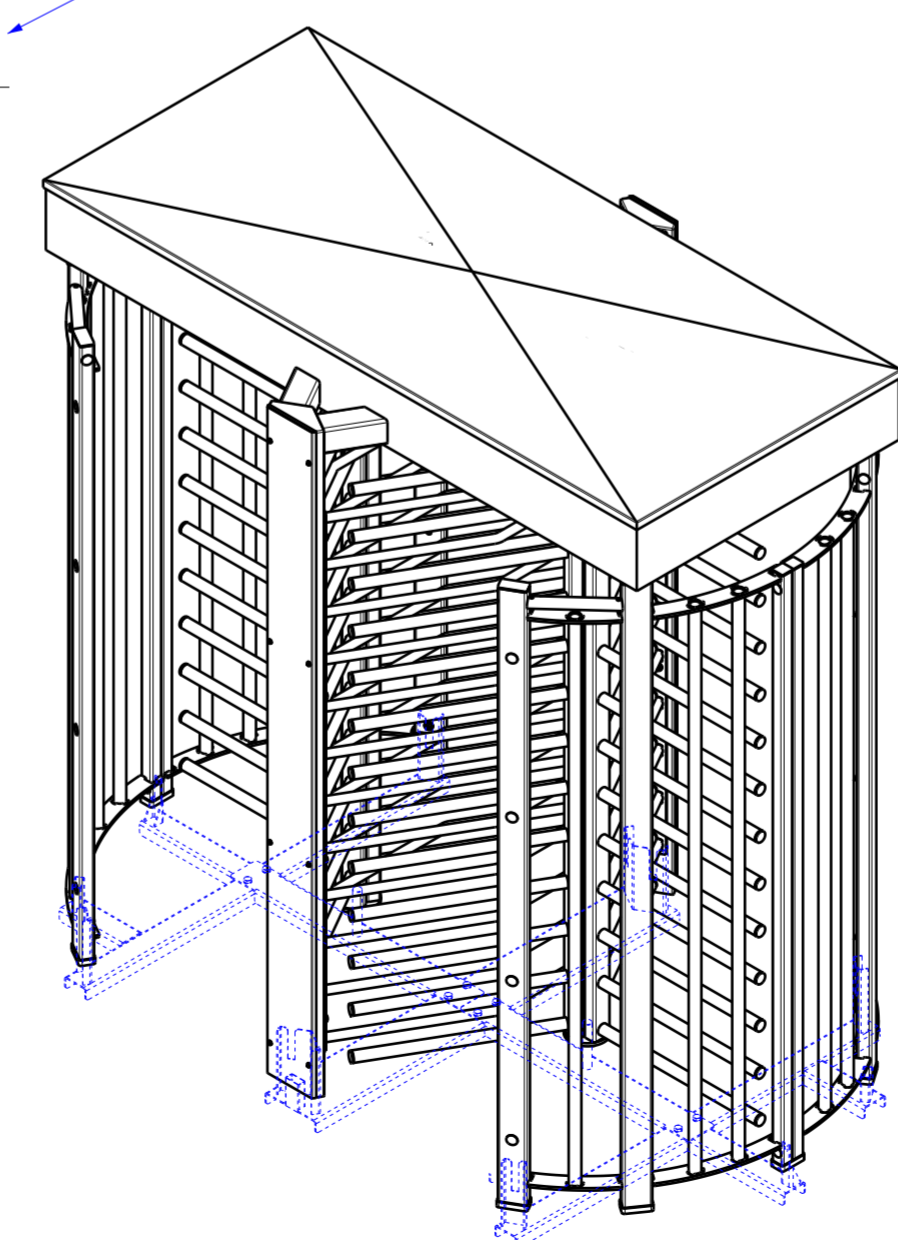

POWER SUPPLY : Single phase 230V + ground with 3G2.5² mm (Type: XFVB recommended)
Control cable Type TPVF ou LiYCY

PVC tube 2xØ25mm for cables

WARNING: If control cables are not of TPVF or LiYCY type foresee a supplementary tube to separate power supply from control cables

ALL CABLES TO BE SUPPLIED WITH A MINIMUM 3 METRE FREE TAIL

Les dimensions sont données en mm.
De afmetingen zijn gegeven in mm.
Ne pas mesurer sur le plan.
Niet meten op het plan.

| | | | | |
|--|-----------------|------------|------------|--------------|
| <p>A ARRIVE DE CABLE Ø50-->2xØ25 CF 07/10/2011</p> | | | | |
| INDICE : | MODIFICATIONS : | PAR : | DATE : | |
| AANWIJZING : | WIJZIGINGEN : | DOOR : | DATUM : | |
| <p>TR372 - INSTALLATION WITH FIXING FRAME</p> | | | | |
| DESIGNATION : | | | | |
| BESTEMMING : | | | | |
| CLIENT : | | | | |
| KLANT : | | | | |
| <p><small>Ce plan est notre propriété et ne peut être cédé à des tiers ni être recopié sans autorisation écrite de Automatic Systems. Dit plan blijft onze eigendom en mag niet voorgelegd aan derden noch worden gekopieerd zonder schriftelijke toelating van Automatic Systems.</small></p> | | | | |
| <p>AUTOMATIC SYSTEMS GBR GROUP</p> <p>Avenue Mercator. 5 - B-1300 Wavre www.automatic-systems.com</p> | | DESSINE : | DATE : | N° DOSSIER : |
| | | GETEKEND : | DATUM : | N° DOSSIER : |
| | | CF | 18/12/2007 | ----- |
| VERIFIE : | ECHELLE : | PLAN N° : | | |
| NAGEZIEN : | SCHAAL : | PLAN N° : | | |
| FM | 1/20 | CH6731-gb | A | |