

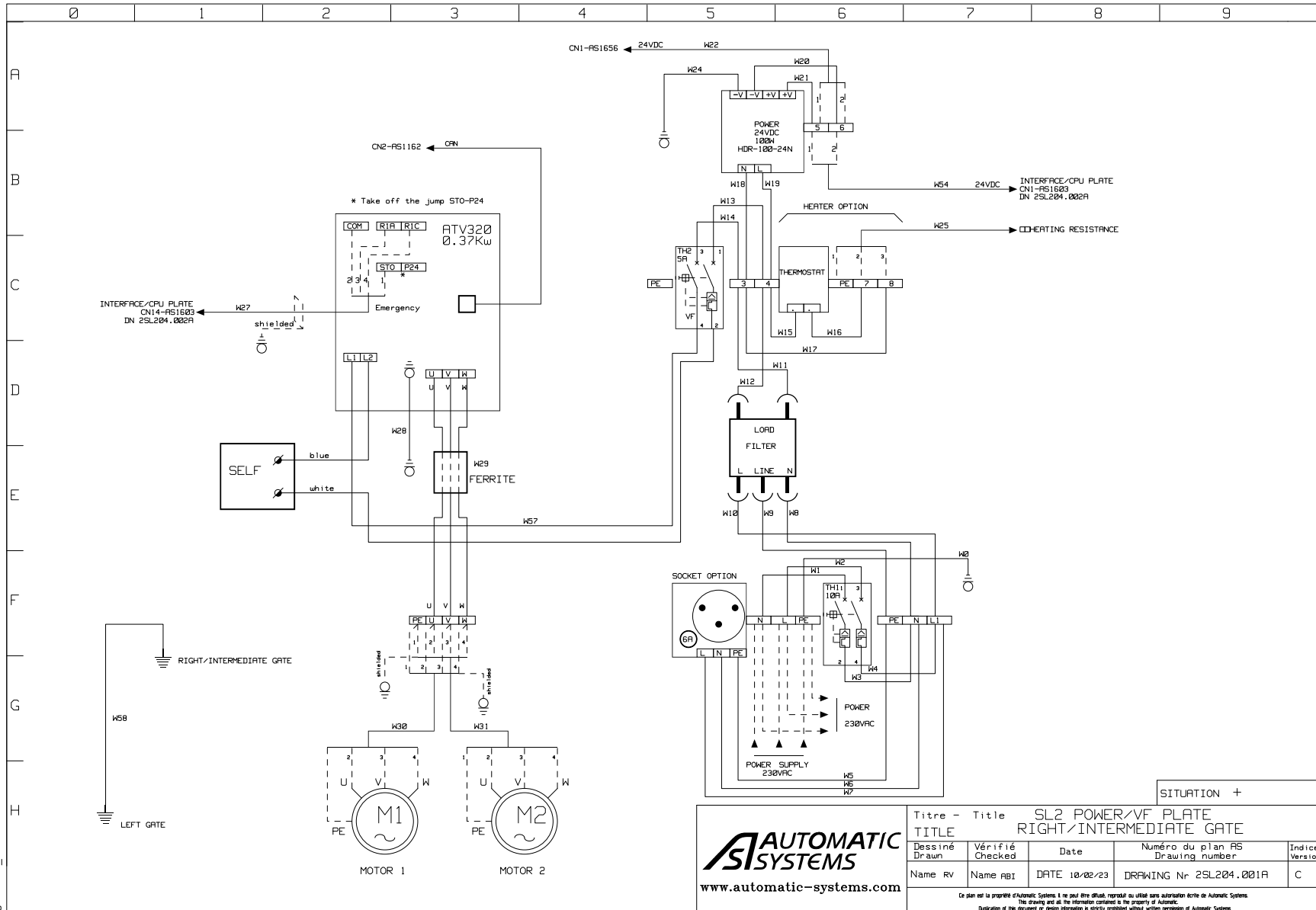

SMARTLANE

SMARTLANE - GLASS SWING GATES



SMARTLANE - GLASS SWING GATES

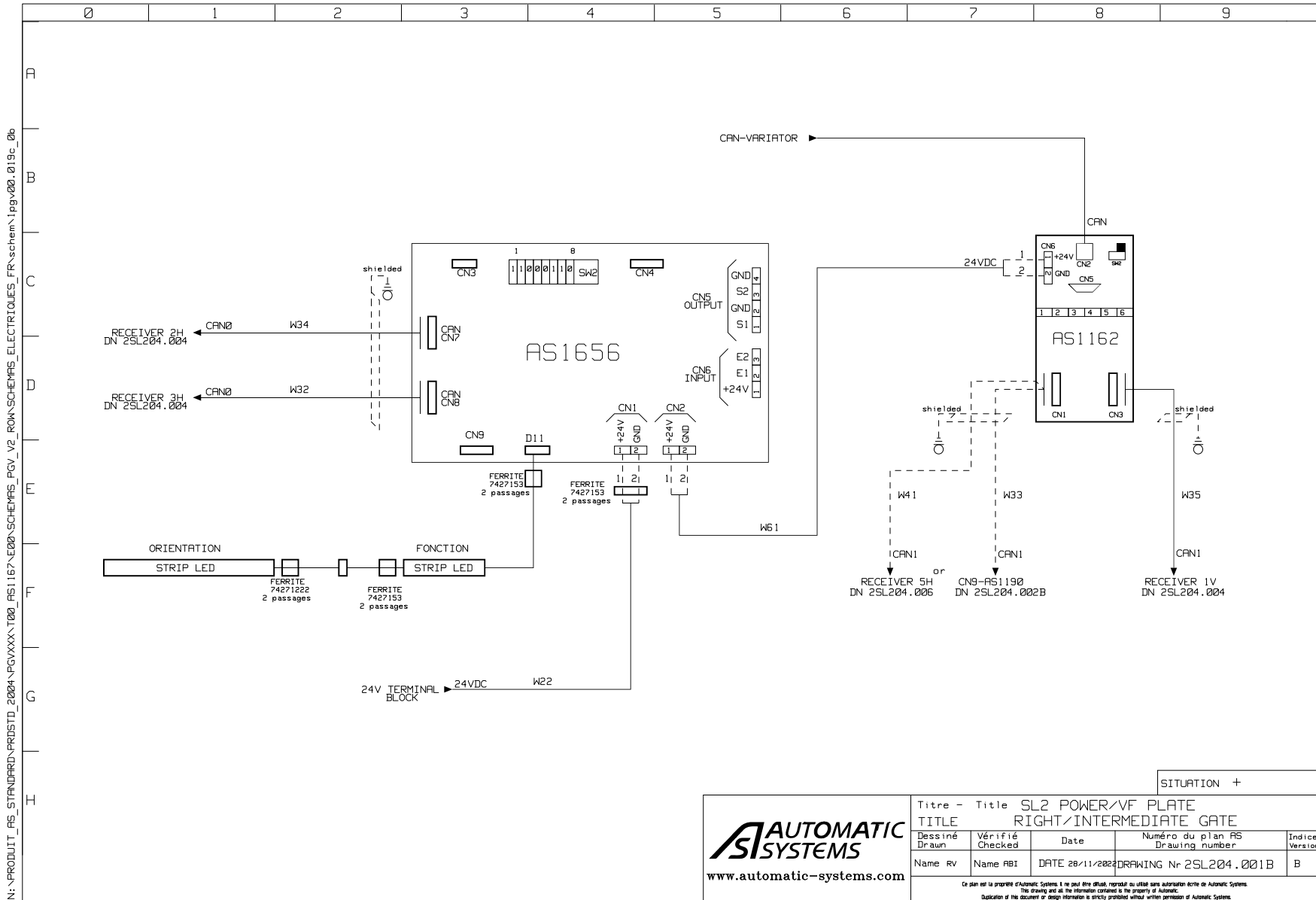

SMARTLANE - GLASS SWING GATES

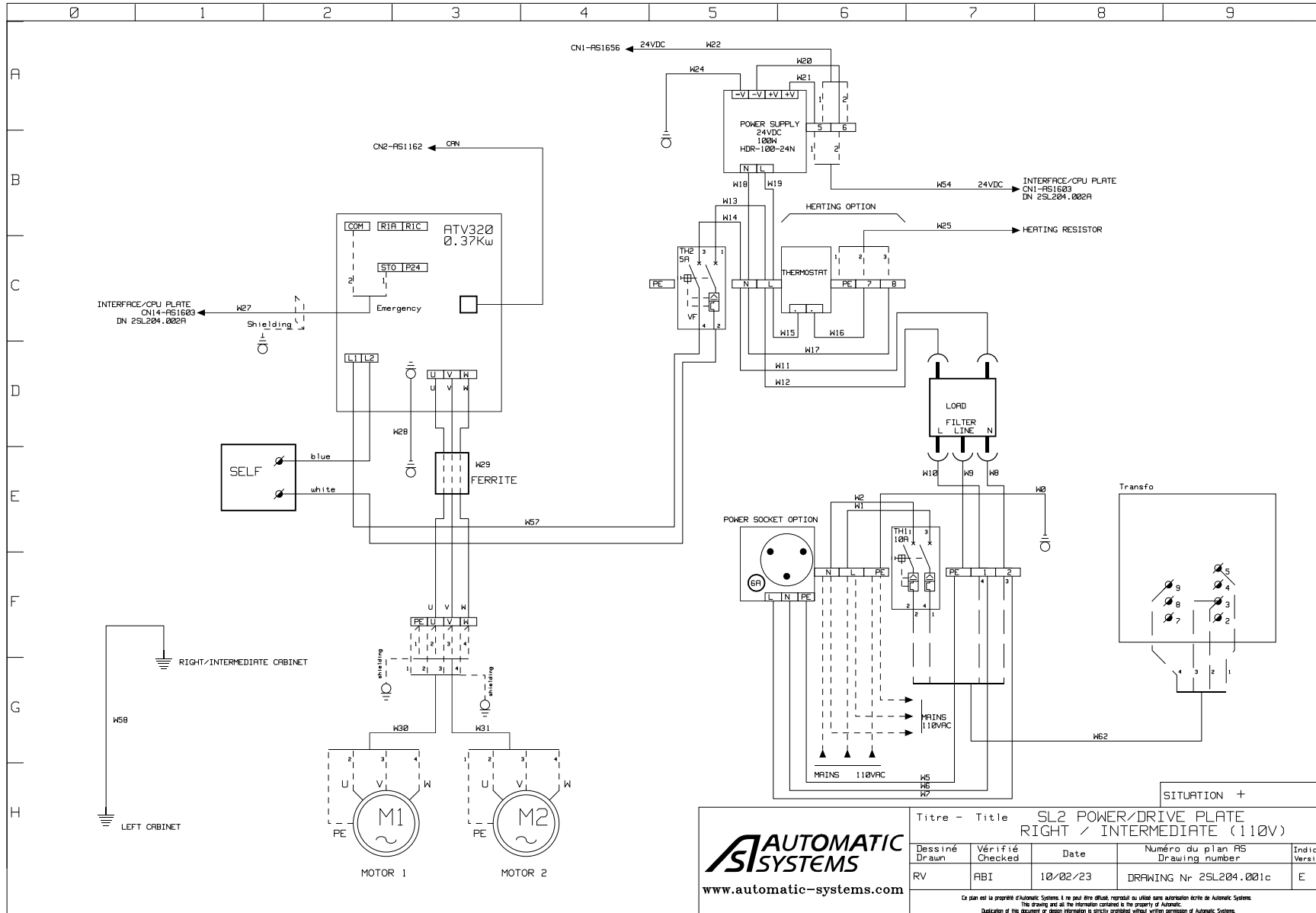

AUTOMATIC SYSTEMS
www.automatic-systems.com

Dessiné		Vérifié		Date	Numéro du plan AS		Indice
Drawn	Checked				Drawing number		Version
RV	ABI			10/02/23	DRAWING Nr 2SL204.001c		E

Ce plan est la propriété d'Automatic Systems. Il ne peut être diffusé, reproduit ou utilisé sans autorisation écrite de Automatic Systems.
The drawing are all the information contained to the property of Automatic.
Duplication of this document or design information is strictly prohibited without written permission of Automatic Systems.

SMARTLANE - GLASS SWING GATES

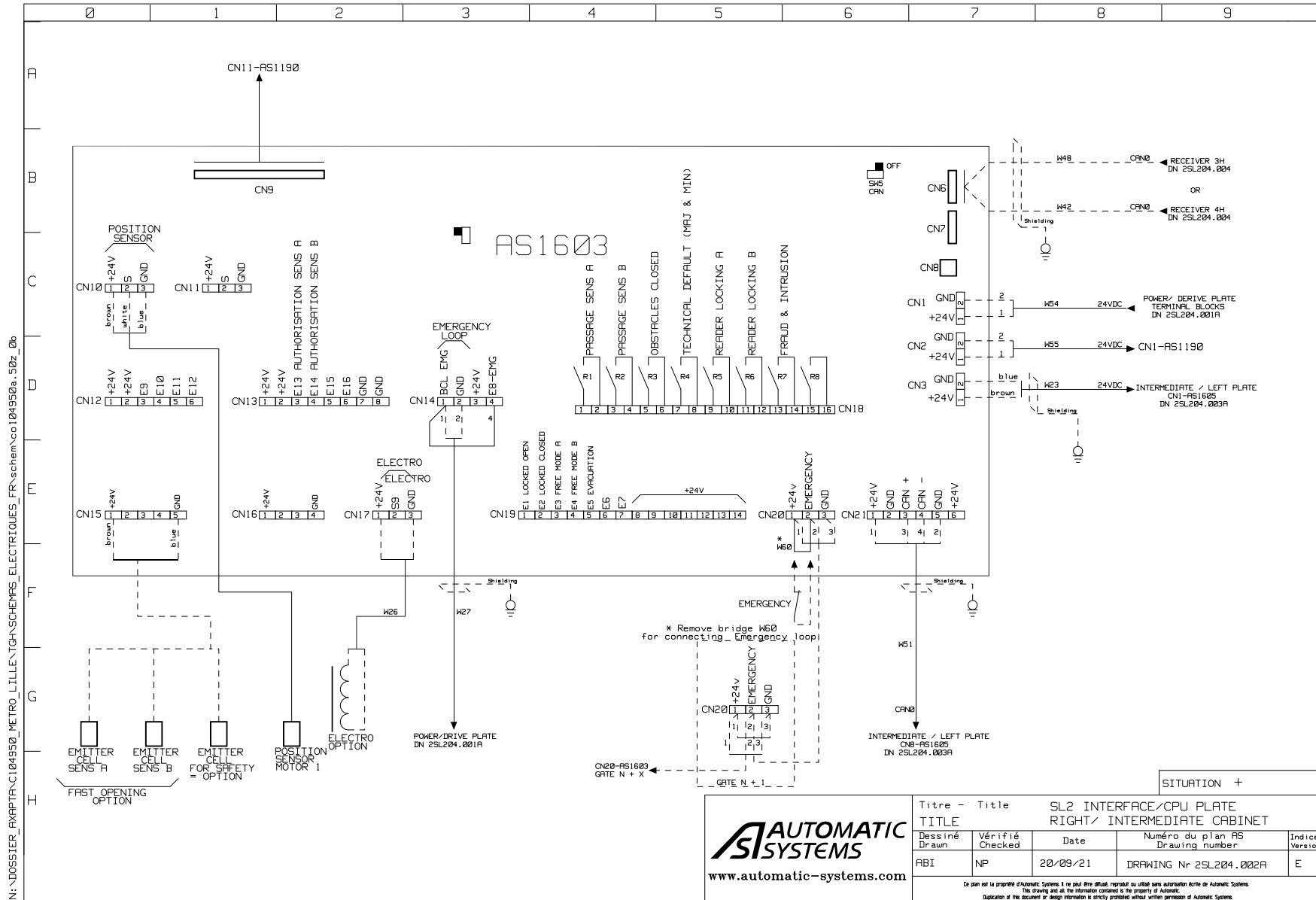

N: \DOSSIER_AXPAT\NC:\04950_METRO_LILLE\TGH\SCHEMS_ELECTRIQUES_FR\schem\col04950a_50z_0b



www.automatic-systems.com

Titre - Title		SL2 INTERFACE / CPU PLATE		
Dessiné Drawn		RIGHT / INTERMEDIATE CABINET		
Vérifié Checked	Date	Numéro du plan AS Drawing number		Indice Version
FBI	NP	20/09/21	DRAWING Nr 2SL204.002A	E

De plan est la propriété d'Automatic Systems et ne peut être diffusé, reproduit ou utilisé sans autorisation écrite de Automatic Systems. This drawing and all the information contained is the property of Automatic. Duplication of this document or design information is strictly prohibited without written permission of Automatic Systems.

SITUATION +

SMARTLANE - GLASS SWING GATES

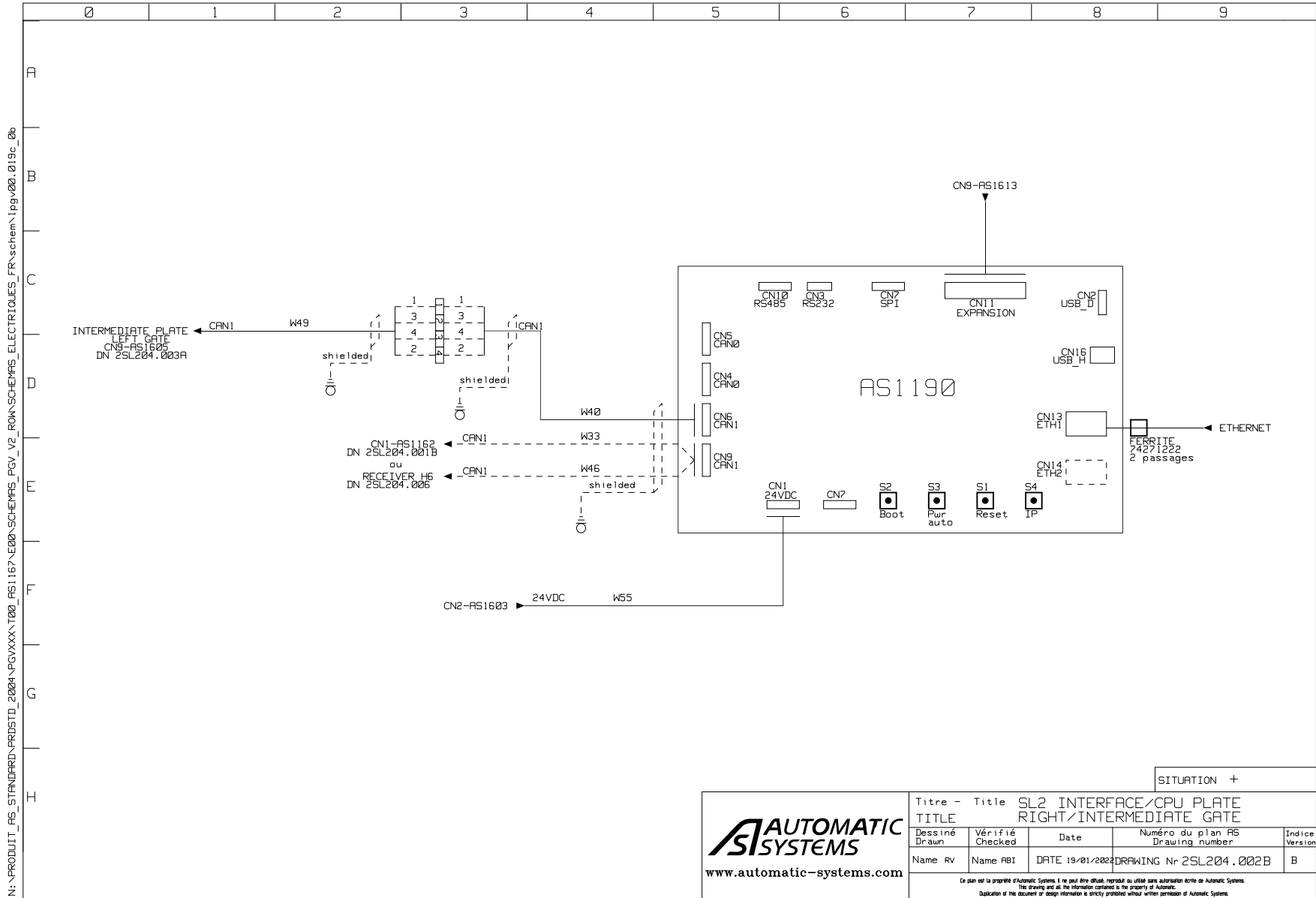

N: \PRODUIT_AS_STANDARD\PROJSTD_2004\PGVXXX\T00_AS1167\EB0\SCHMAS_FOV_V2_ROW\SCHMAS_ELECTRIQUES_FR\schem\pgv00.019c_0b

SITUATION +



Titre - Title		SL2 INTERFACE/CPU PLATE RIGHT/INTERMEDIATE GATE		
Dessiné Drawn	Vérifié Checked	Date	Numéro du plan AS Drawing number	Indice Version
Name RV	Name ABI	DATE 19/01/2024	DRAWING N° 2SL204.002B	B
<small> Ce plan est la propriété d'Automatic Systems. Il ne peut être diffusé, réproduit ou utilisé sans autorisation écrite de Automatic Systems. This drawing and all the information contained in the property of Automatic Systems. Duplication of the document or design information is strictly prohibited without written permission of Automatic Systems. </small>				

SMARTLANE - GLASS SWING GATES

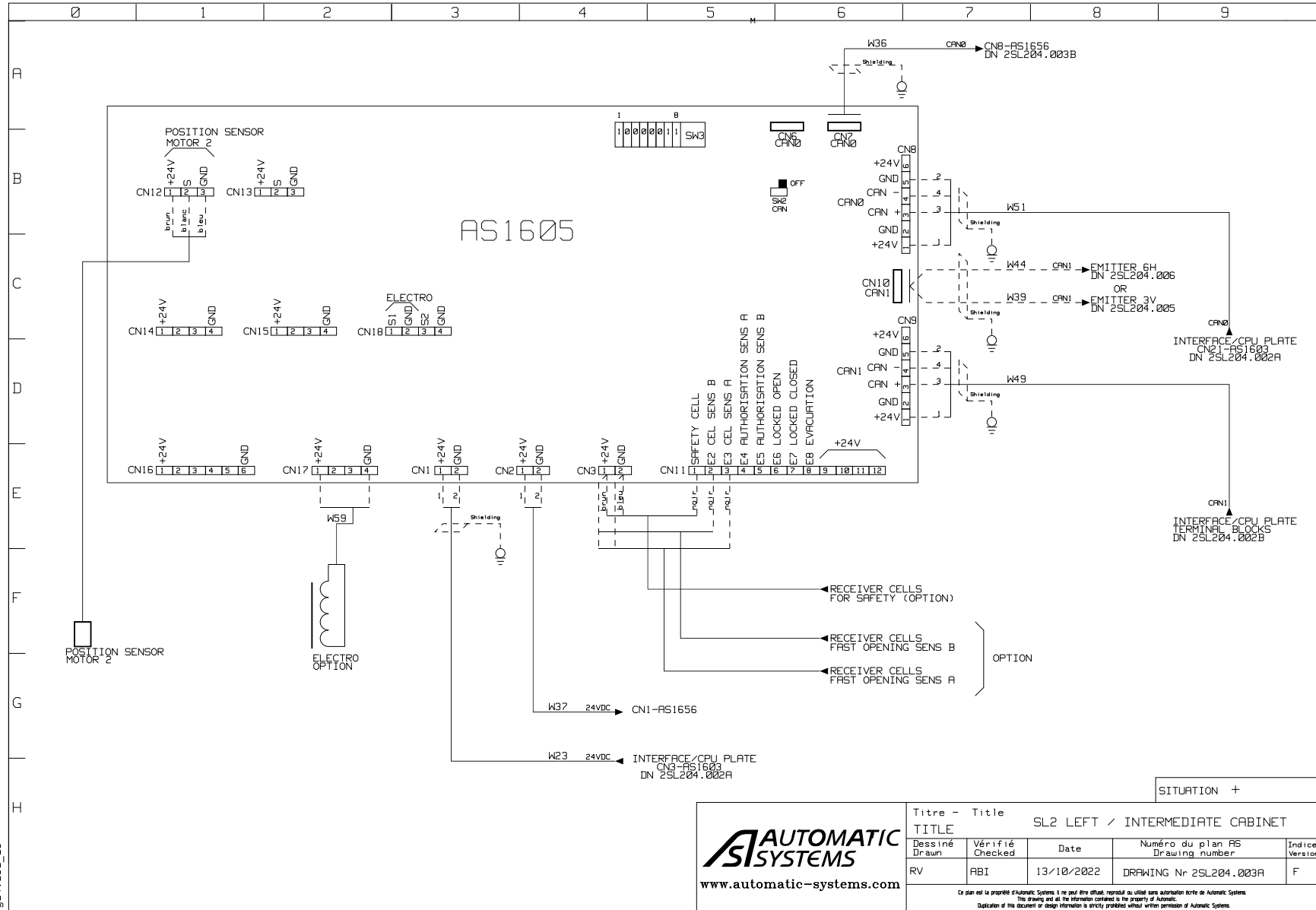

9/24_05/0_0e



Titre - Title		SL2 LEFT / INTERMEDIATE CABINET		
Dessiné Drawn	Vérfié Checked	Date	Número du plan AS Drawing number	Indice Version
RV	ABI	13/10/2022	DRAWING Nr 2SL204.003A	F
<p><small>Ce plan est la propriété d'Automatic Systems. Il ne peut être utilisé, reproduit ou utilisé sans autorisation écrite de Automatic Systems. This drawing and all the information contained is the property of Automatic. Duplication of this document or design information is strictly prohibited without written permission of Automatic Systems.</small></p>				

SITUATION +

SMARTLANE - GLASS SWING GATES

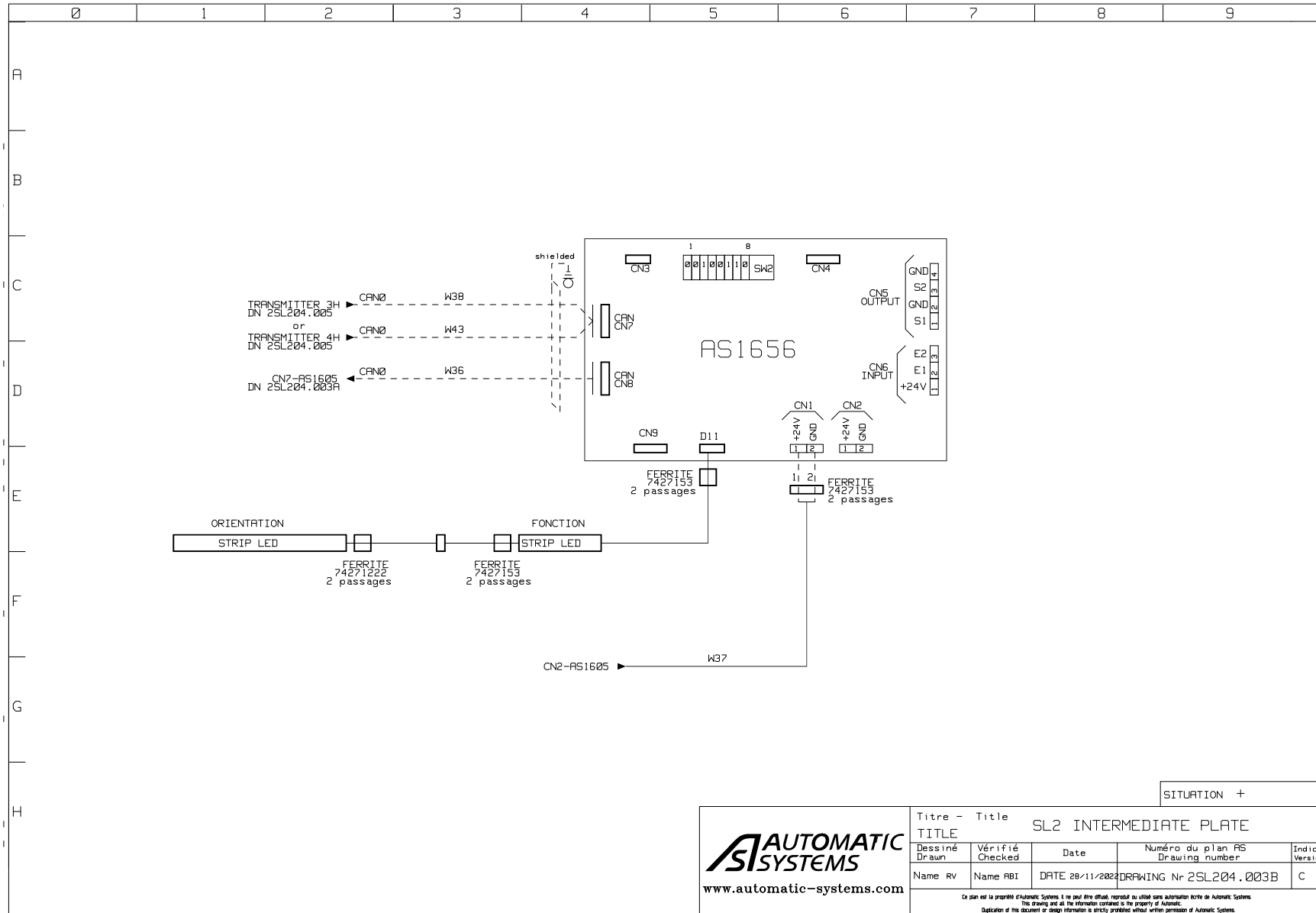

AUTOMATIC SYSTEMS
www.automatic-systems.com

Titre - Title		SL2 INTERMEDIATE PLATE		
Dessiné Braun		Vérifié Checked	Date	Numéro du plan AS Drawing number
Name RV		Name AB1	DATE 28/11/2024	DRAWING N° 2SL204.003B
				Indice Version C

Ce plan est la propriété d'Automatic Systems. Il ne peut être diffusé, reproduit ou utilisé sans autorisation écrite de Automatic Systems.
This drawing and all the information contained is the property of Automatic.
Duplication of this document or design information is strictly prohibited without written permission of Automatic Systems.

SMARTLANE - GLASS SWING GATES

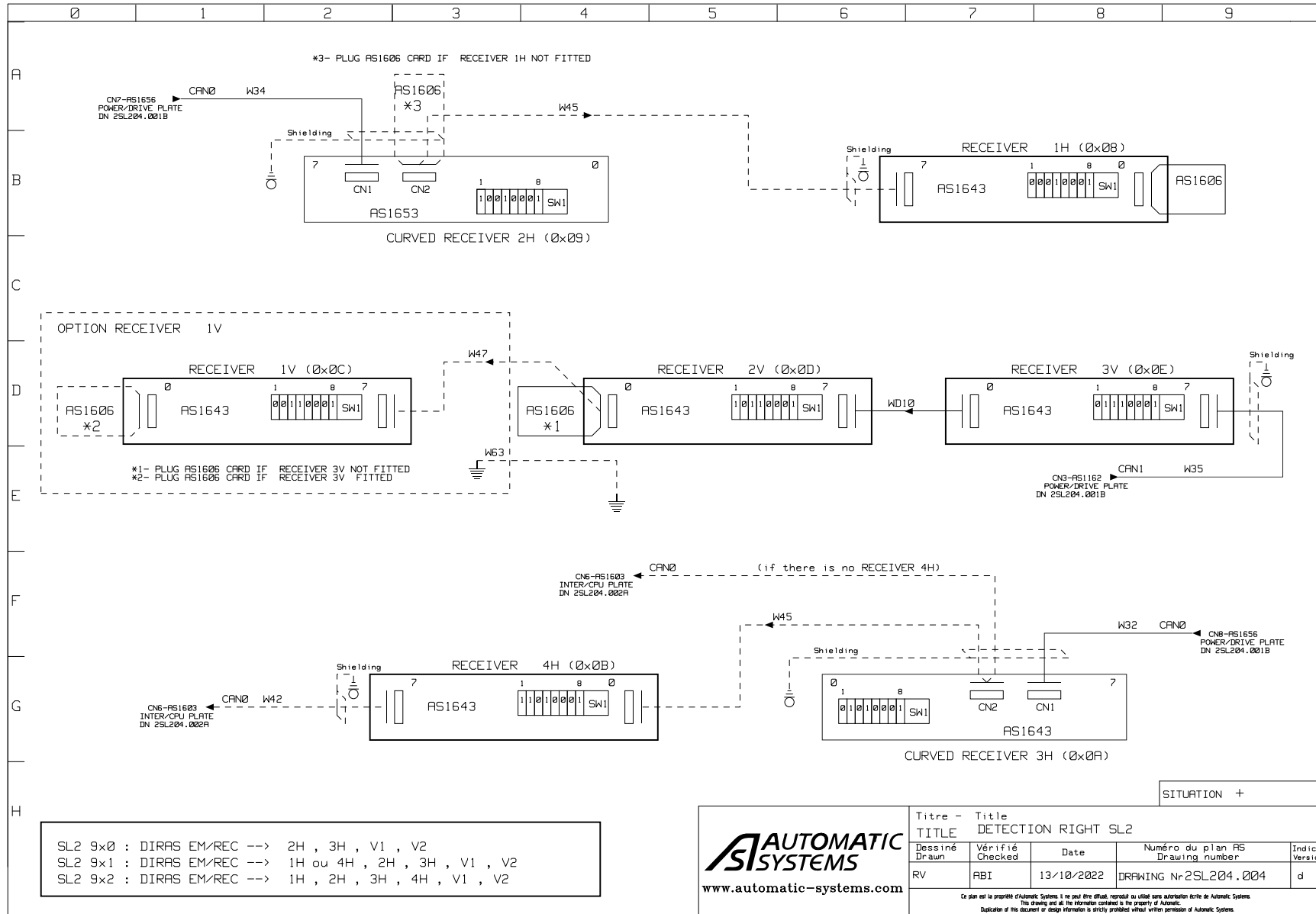

SL2 9x0 : DIRAS EM/REC --> 2H , 3H , V1 , V2
 SL2 9x1 : DIRAS EM/REC --> 1H ou 4H , 2H , 3H , V1 , V2
 SL2 9x2 : DIRAS EM/REC --> 1H , 2H , 3H , 4H , V1 , V2

AUTOMATIC SYSTEMS
www.automatic-systems.com

Titre - Title		TITRE DETECTION RIGHT SL2		SITUATION +	
Dessiné Drawn	Vérifié Checked	Date	Número du plan AS Drawing number	Indice Version	
RV	ABI	13/10/2022	DRAWING N° 2SL204.004	d	

Ce plan est la propriété d'Automatic Systems. Il ne peut être diffusé, reproduit ou utilisé sans autorisation écrite de Automatic Systems.
 This drawing and all the information contained is the property of Automatic.
 Duplication of this document or design information is strictly prohibited without written permission of Automatic Systems.

SMARTLANE - GLASS SWING GATES

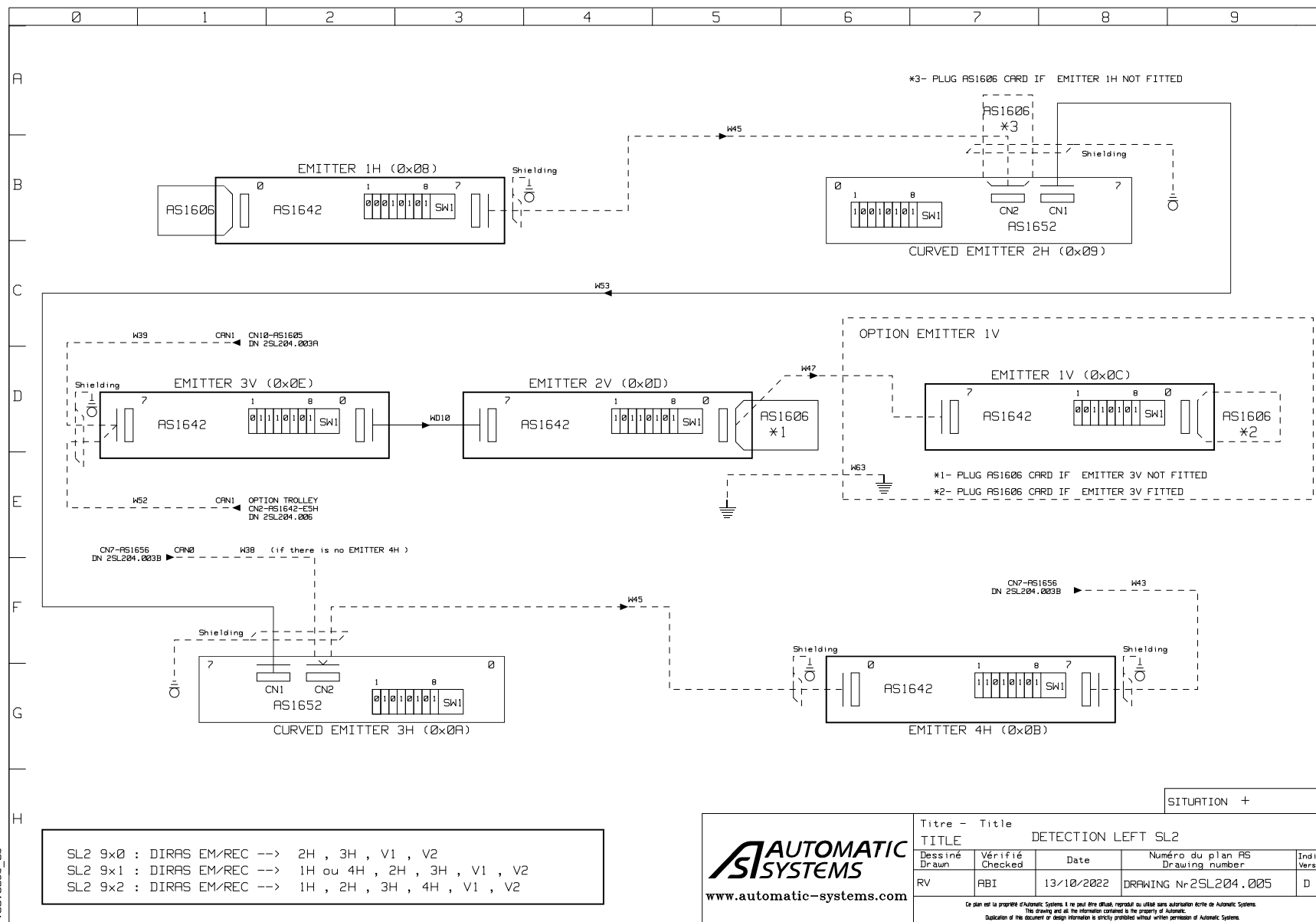

SL2 9x0 : DIRAS EM/REC -->	2H , 3H , V1 , V2
SL2 9x1 : DIRAS EM/REC -->	1H ou 4H , 2H , 3H , V1 , V2
SL2 9x2 : DIRAS EM/REC -->	1H , 2H , 3H , 4H , V1 , V2



www.automatic-systems.com

Titre - Title				
TITLE DETECTION LEFT SL2				
Dessiné	Vérifié	Date	Numéro du plan AS	
Drawn	Checked		Drawing number	
RV	FBI	13/10/2022	DRAWING N° 2SL204.005	Indice
				D
<small> Ce plan est la propriété d'Automatic Systems. Il ne peut être réutilisé, reproduit ou diffusé sans autorisation écrite de Automatic Systems. This drawing and all the information contained is the property of Automatic. Duplication of this document or design information is strictly prohibited without written permission of Automatic Systems. </small>				

v003_00056_06

SITUATION +

SMARTLANE - GLASS SWING GATES

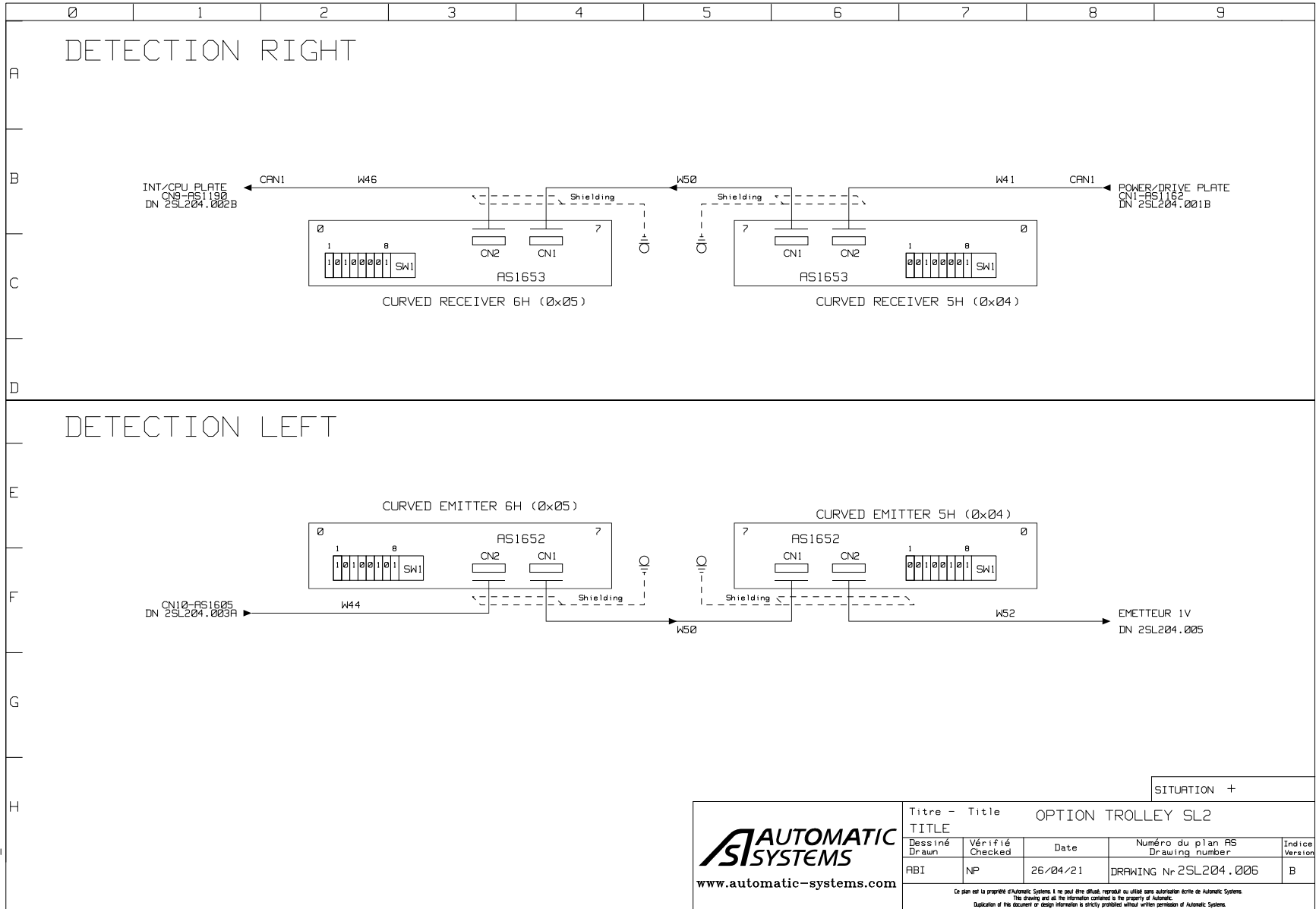

v200.001c_06

SITUATION +



Titre - Title		OPTION TROLLEY SL2		
TITLE				
Dessiné Drawn	Vérifié Checked	Date	Numéro du plan AS Drawing number	Indice Version
FBI	NP	26/04/21	DRAWING N° 2SL204.005	B
<small> Ce plan est la propriété d'Automatic Systems. Il ne peut être diffusé, reproduit ou utilisé sans autorisation écrite de Automatic Systems. This drawing and all the information contained in the property of Automatic. Duplication of the document or design information is strictly prohibited without written permission of Automatic Systems. </small>				

SMARTLANE - GLASS SWING GATES

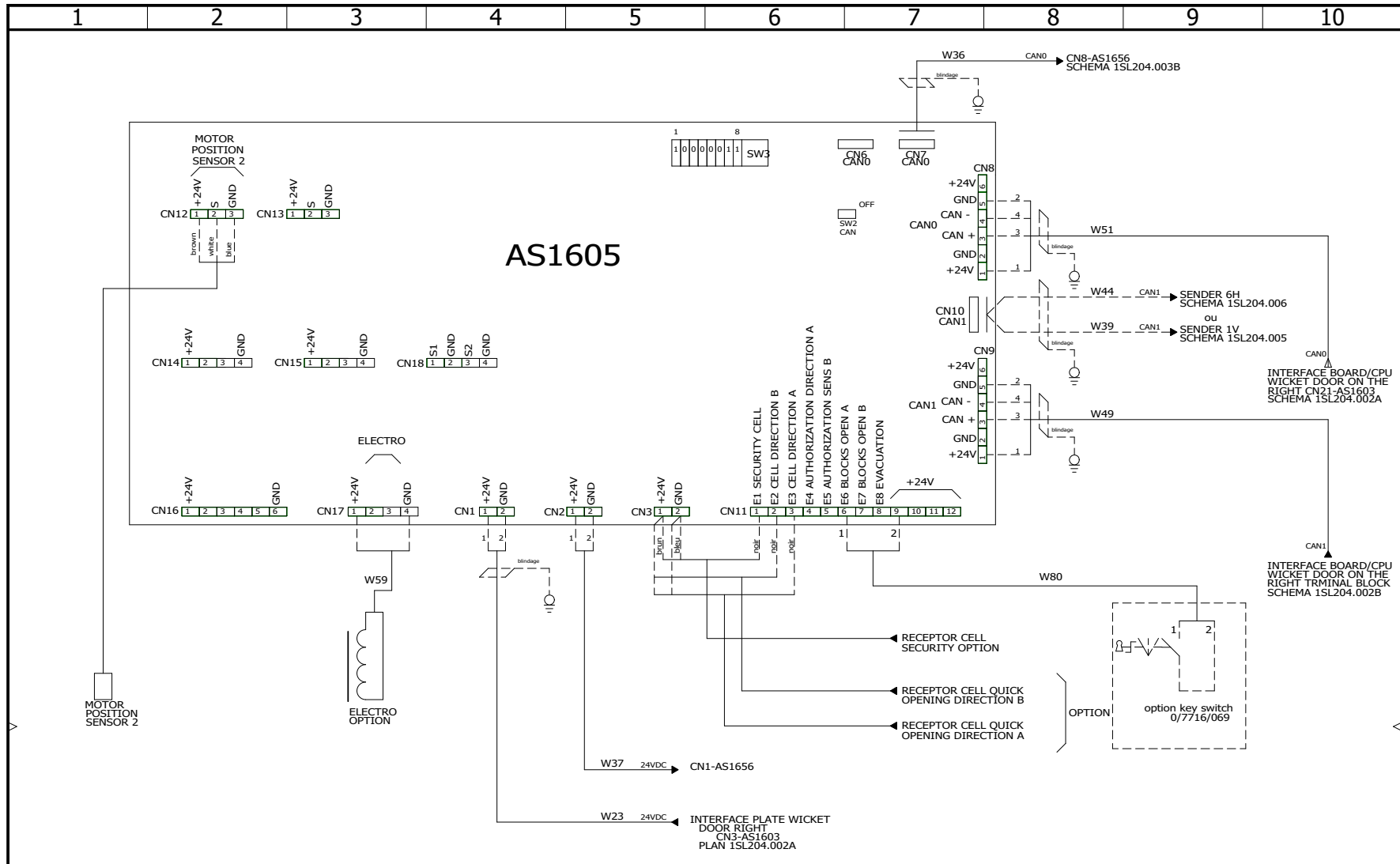

	SMARTLANE V2 KEY SWITCH			REVISION
	0	24-05-22	vroze	0
CONTRACT:	LOCATION: +L1	SMARTLANE LEFT FURNITURE	REV.	SCHEME
			NAME	01
			CHANGES	
		User data 1	User data 2	

SMARTLANE - GLASS SWING GATES

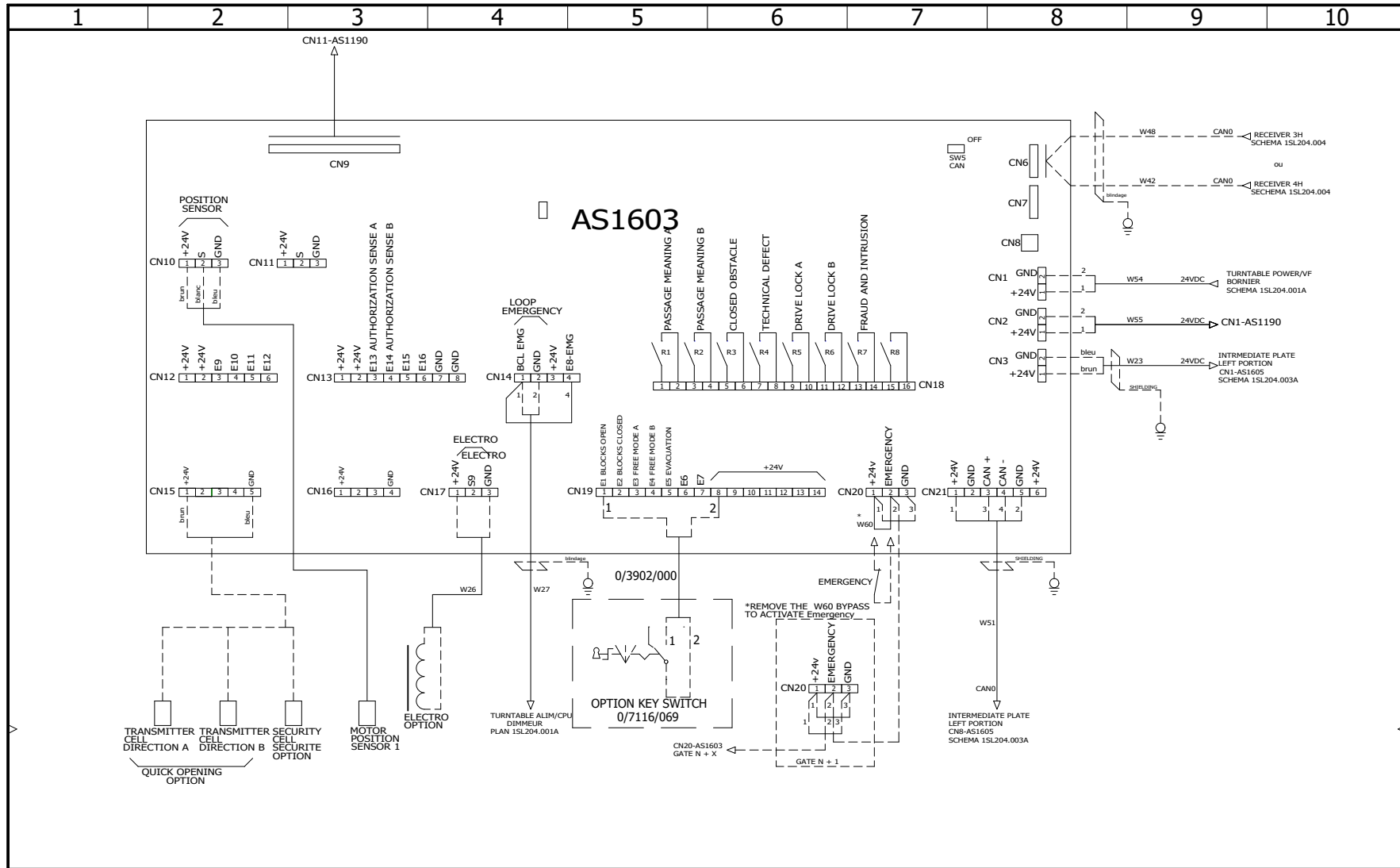

	<h2>SMARTLANE V2 KEY SWITCH</h2>			REVISION 0								
	CONTRACT:	LOCATION: +L1	SMARTLANE RIGHT FURNITURE	<table border="1"> <thead> <tr> <th>REV.</th> <th>DATE</th> <th>NAME</th> <th>CHANGES</th> </tr> </thead> <tbody> <tr> <td>0</td> <td>24-05-22</td> <td>vroze</td> <td></td> </tr> </tbody> </table> User data 1	REV.	DATE	NAME	CHANGES	0	24-05-22	vroze	
REV.	DATE	NAME	CHANGES									
0	24-05-22	vroze										
Document realized with version : 2021.0.3.5				SCHEME 01								