

SECURE GATES

Lösningar för kunder med krav

AUTOMATIC
SI SYSTEMS

EN

|| SlimLane™



SLIMLANE

Rév. 03 • Mise à jour 04/2024



www.automatic-systems.com

SLIMLANE - GLASS SWING GATES

ENGLISH

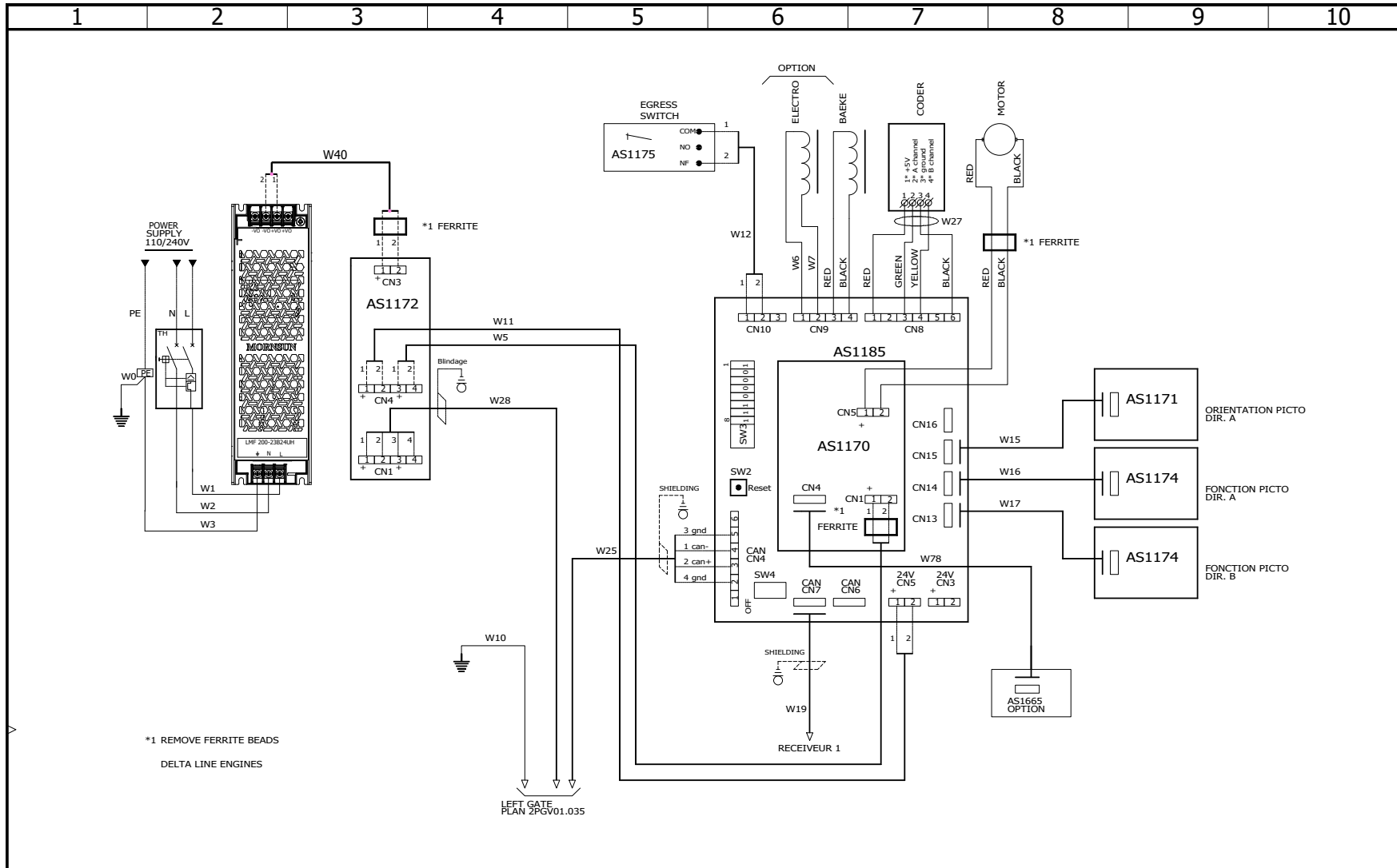

2PGV01.034A

LOCATION:
SLIMLANE 9XX RICHT V2 ROW

CONTRACT:

REV.	DATE	NAME	CHANGES	REVISION
0	16-04-24	vroze		0
				SCHEME
				1

SLIMLANE - GLASS SWING GATES

ENGLISH

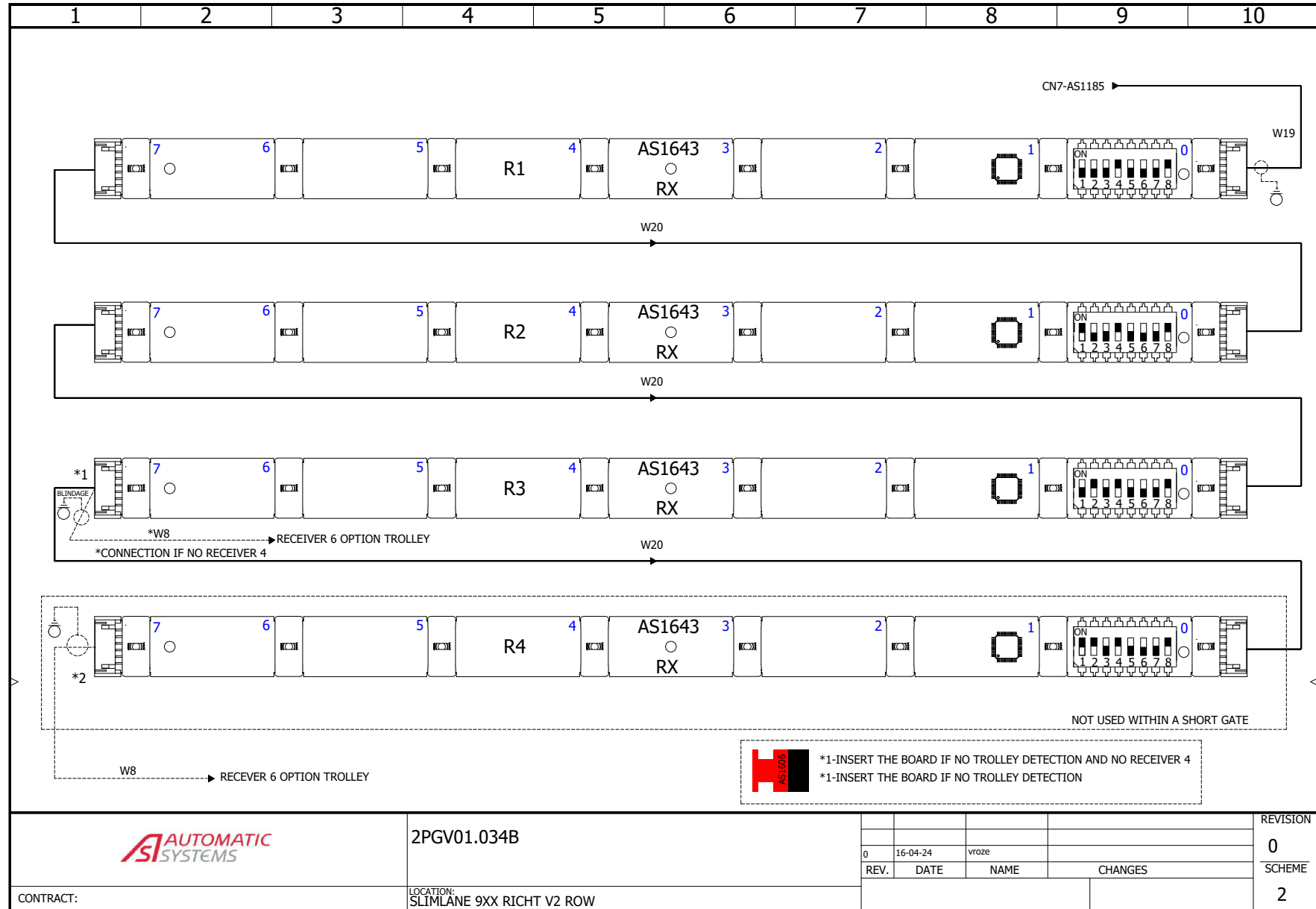

SLIMLANE - GLASS SWING GATES

ENGLISH

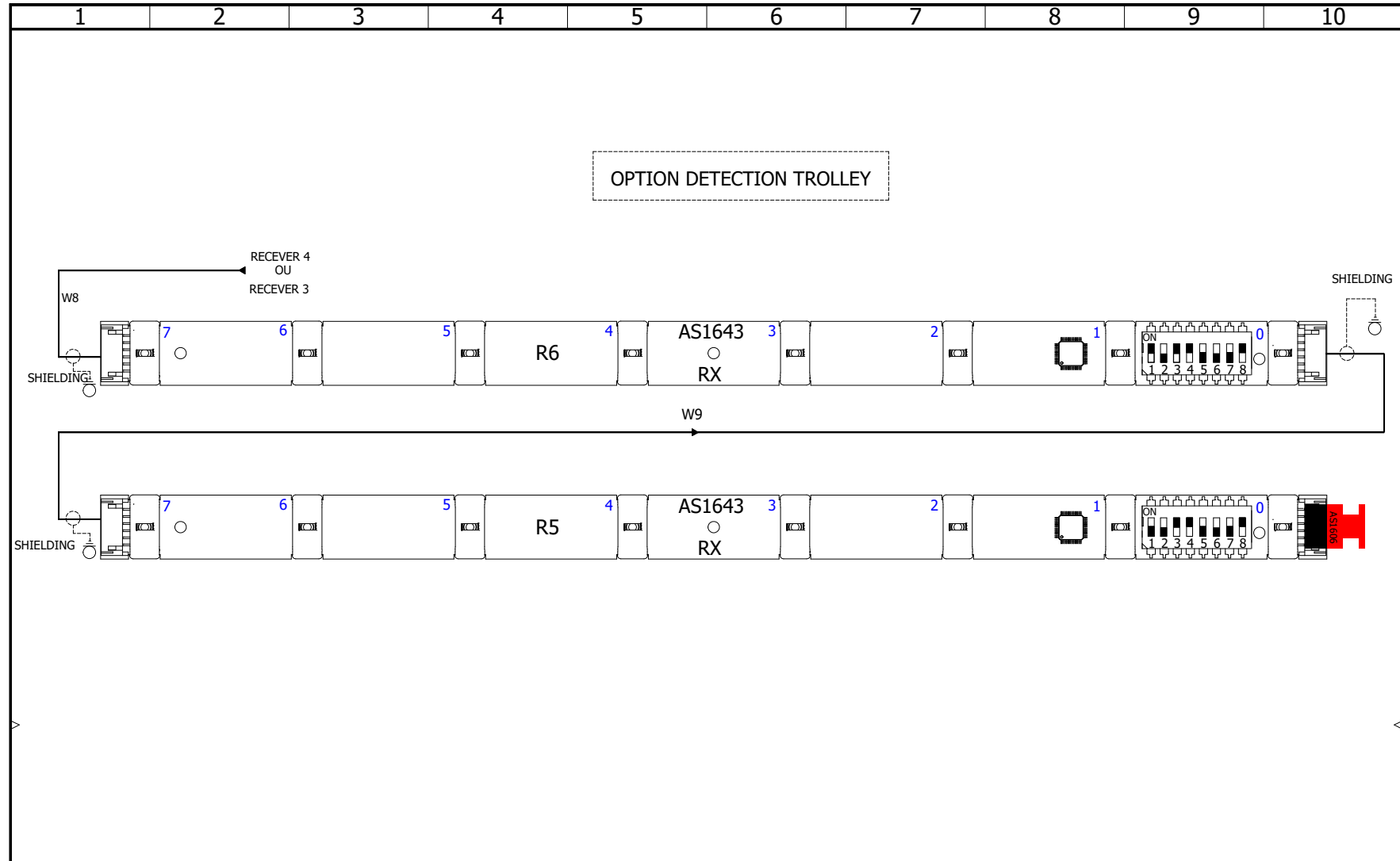

	2PGV01.034C				REVISION
					0
CONTRACT:	LOCATION: SLIMLANE 9XX RICHT V2 ROW	0	16-04-24	vroze	CHANGES
		REV.	DATE	NAME	
					SCHEME
					3

Document realized with version : 2021.0.5.7

SLIMLANE - GLASS SWING GATES

ENGLISH

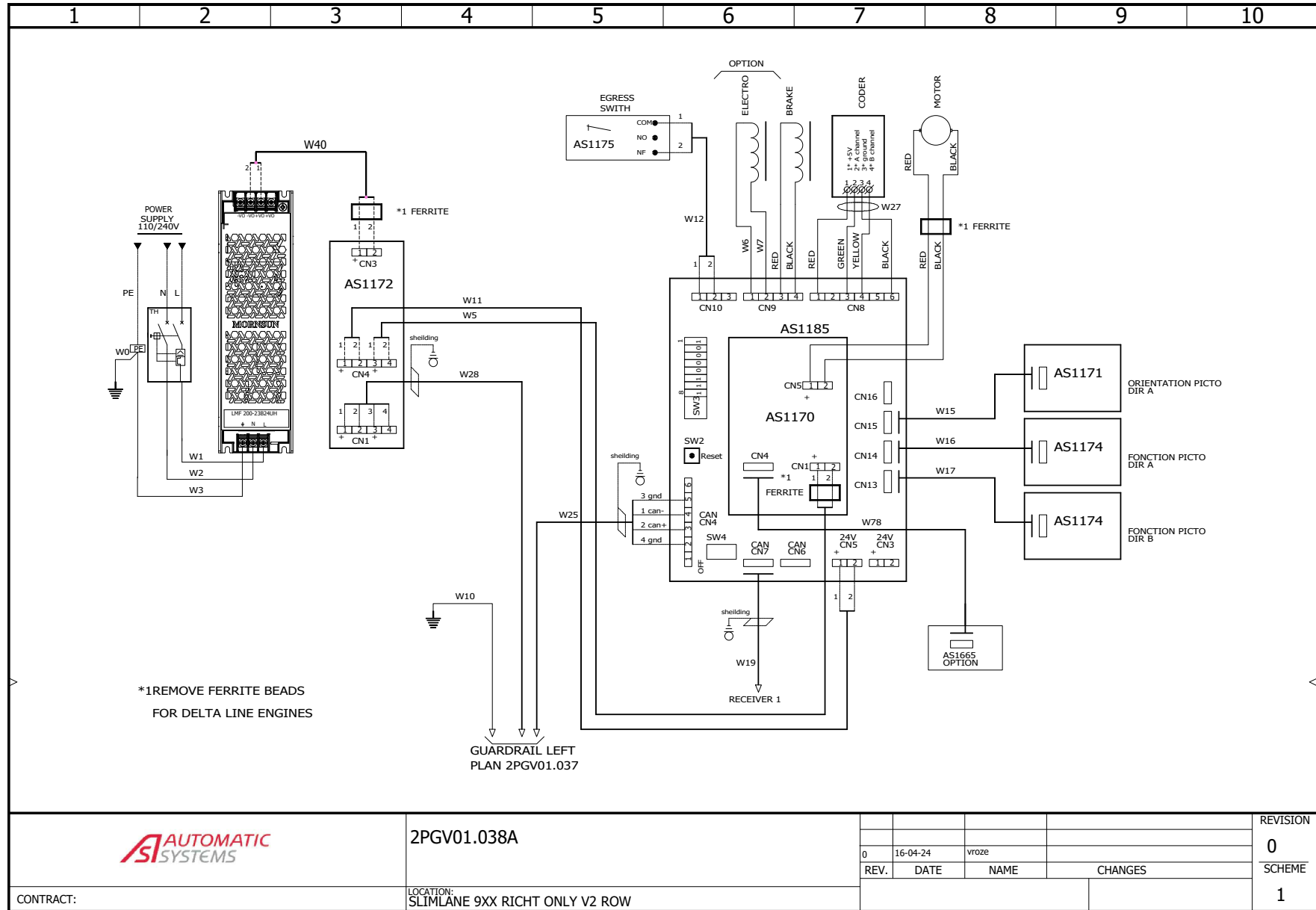

AS AUTOMATIC SYSTEMS

2PGV01.038A

LOCATION: SLIMLANE 9XX RICHT ONLY V2 ROW

REV.	DATE	NAME	CHANGES	REVISION
0	16-04-24	vroze		0
				SCHEME
				1

CONTRACT:

Document realized with version : 2021.0.5.7

SLIMLANE - GLASS SWING GATES

ENGLISH

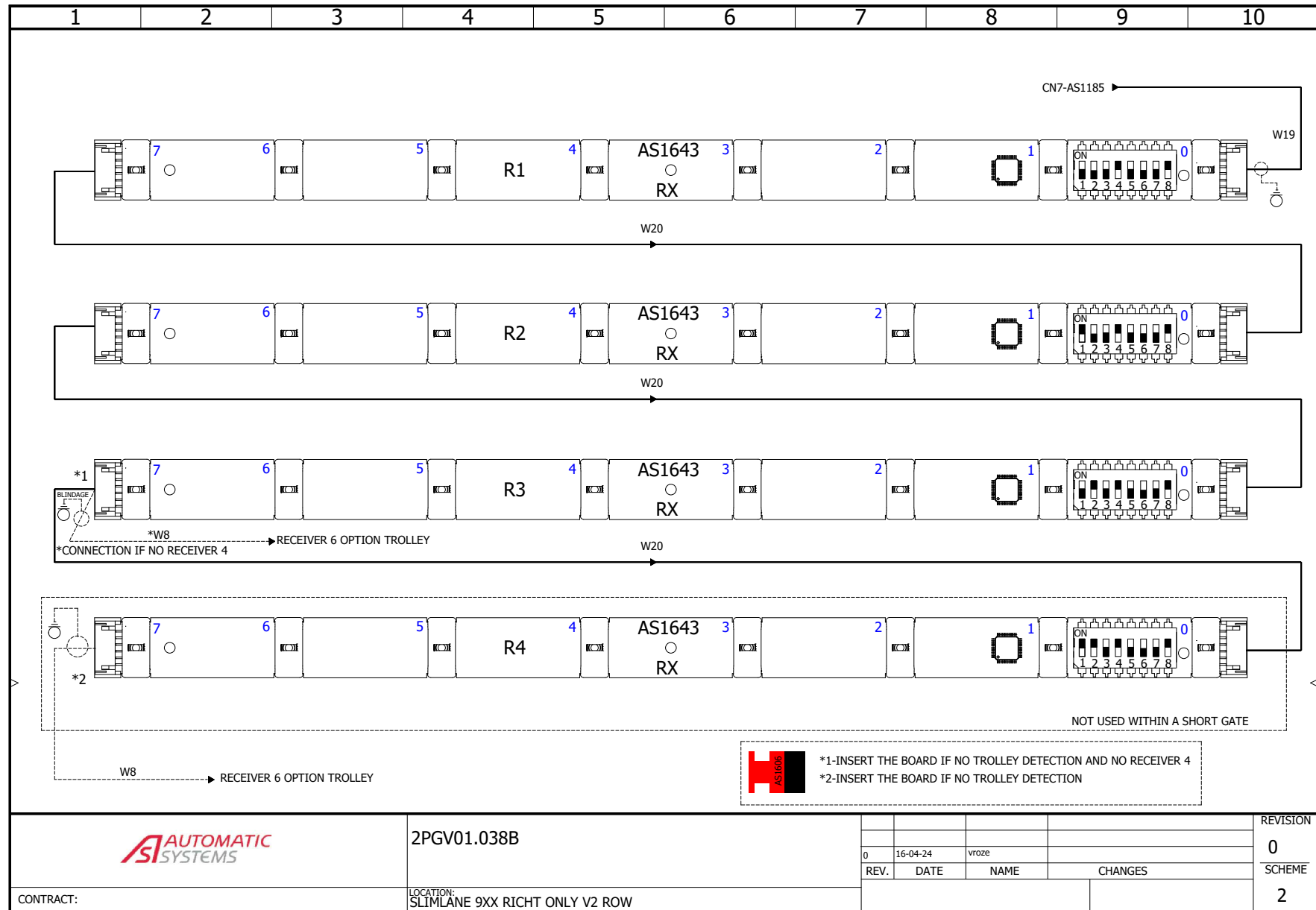

SLIMLANE - GLASS SWING GATES

ENGLISH

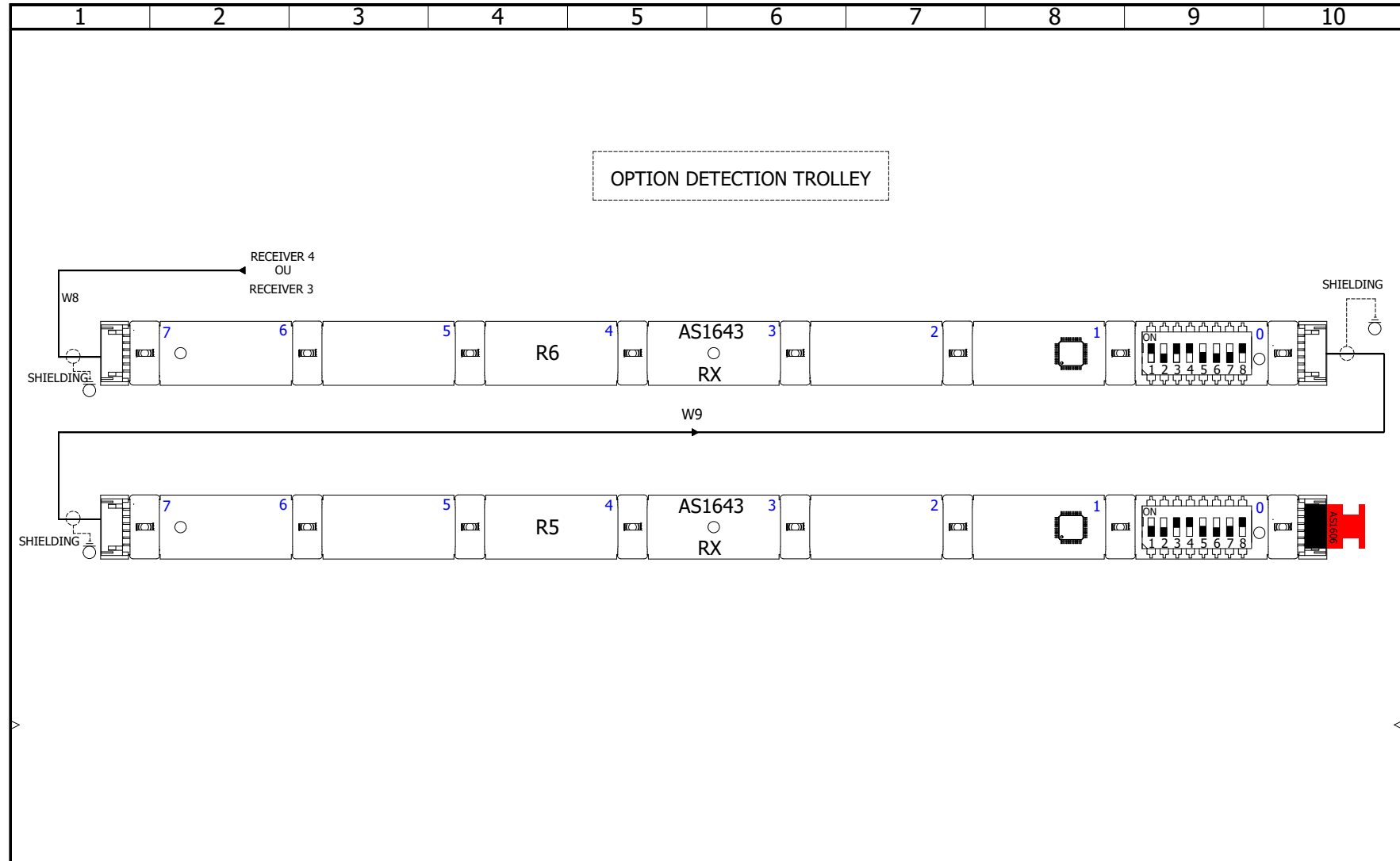

	2PGV01.038C				REVISION
					0
CONTRACT:	LOCATION: SLIMLANE 9XX RICHT ONLY V2 ROW	0	16-04-24	vroze	CHANGES
		REV.	DATE	NAME	
					SCHEME
					3

Document realized with version : 2021.0.5.7

SLIMLANE - GLASS SWING GATES

ENGLISH

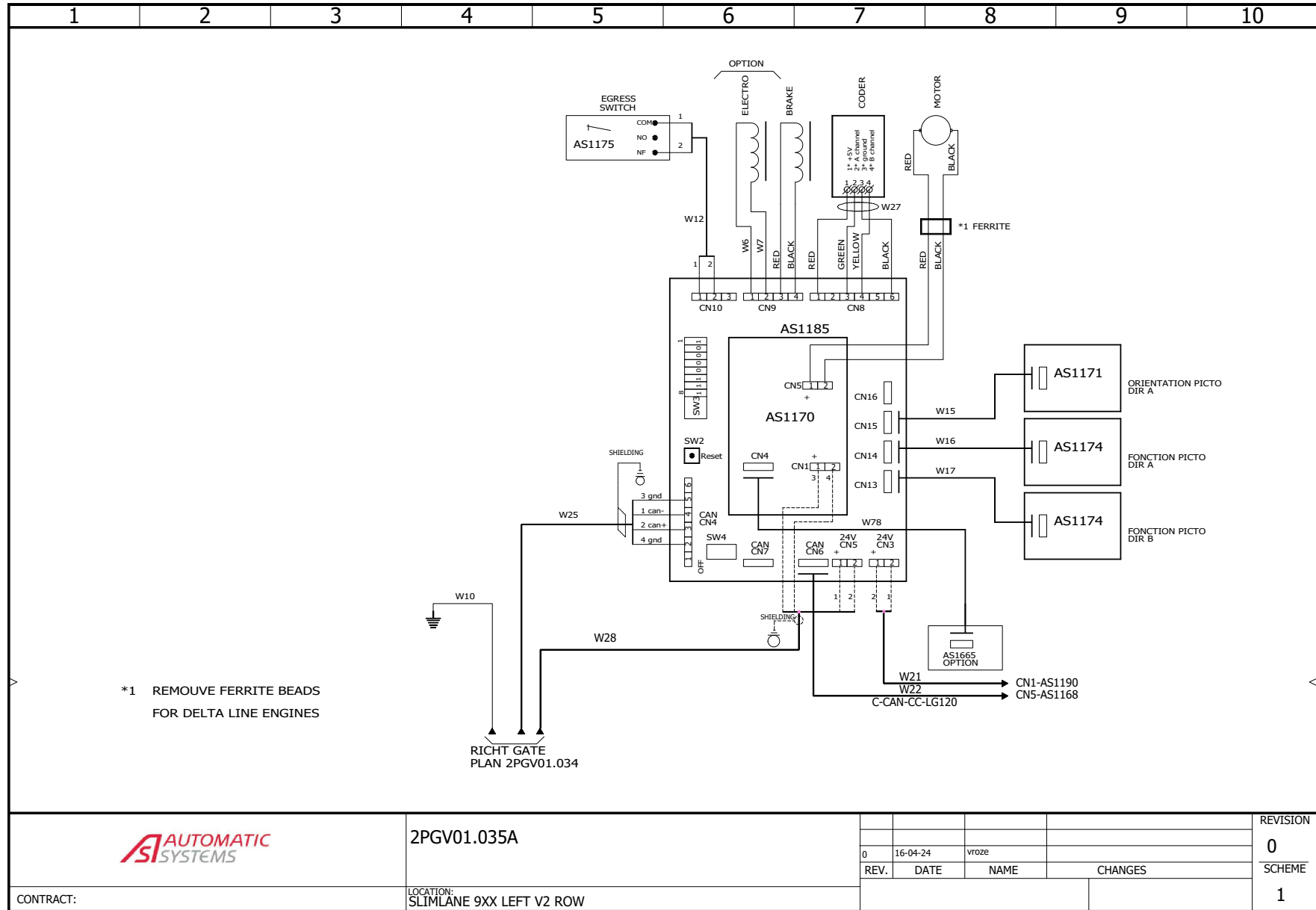

SLIMLANE - GLASS SWING GATES

ENGLISH

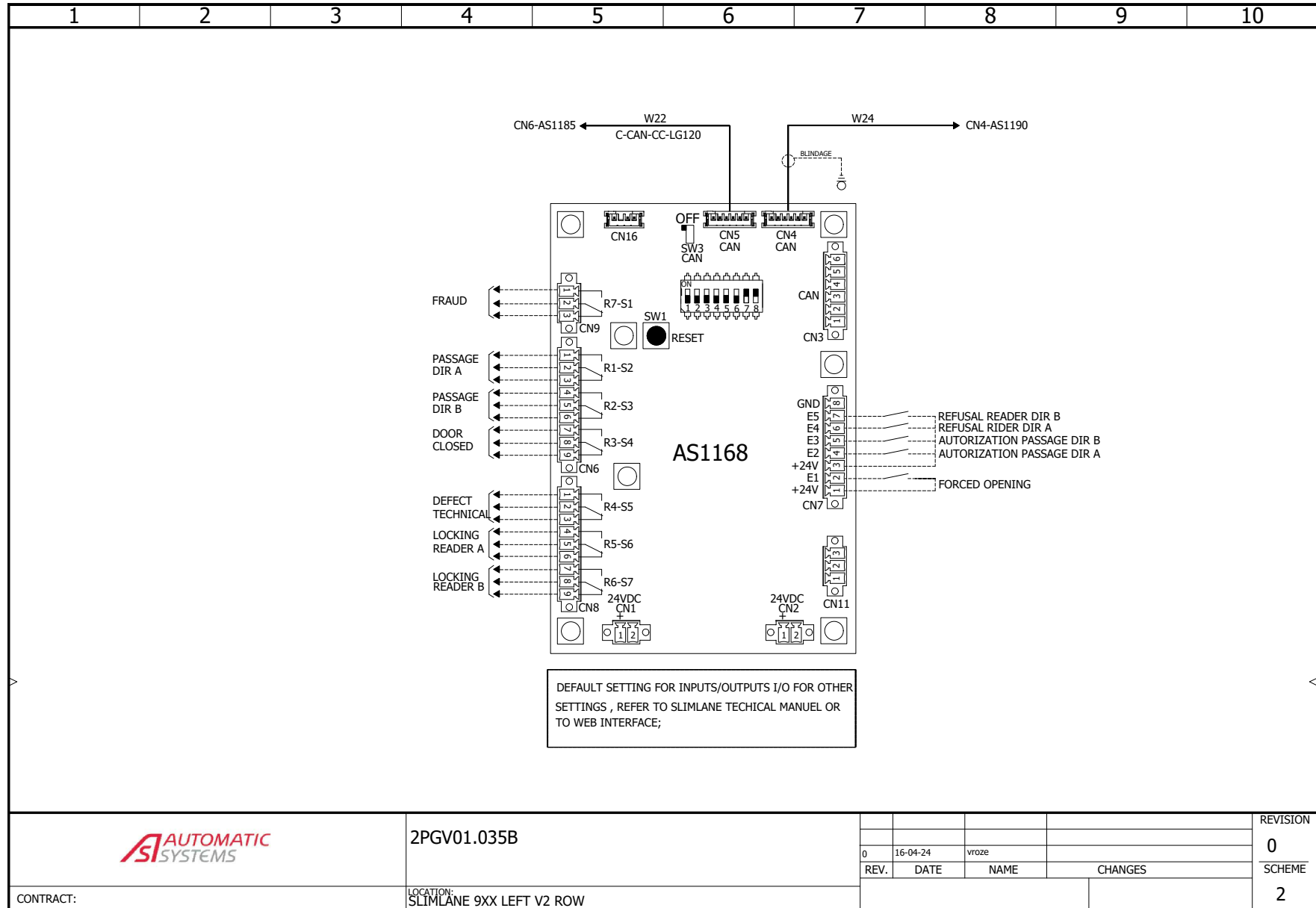

SLIMLANE - GLASS SWING GATES

ENGLISH

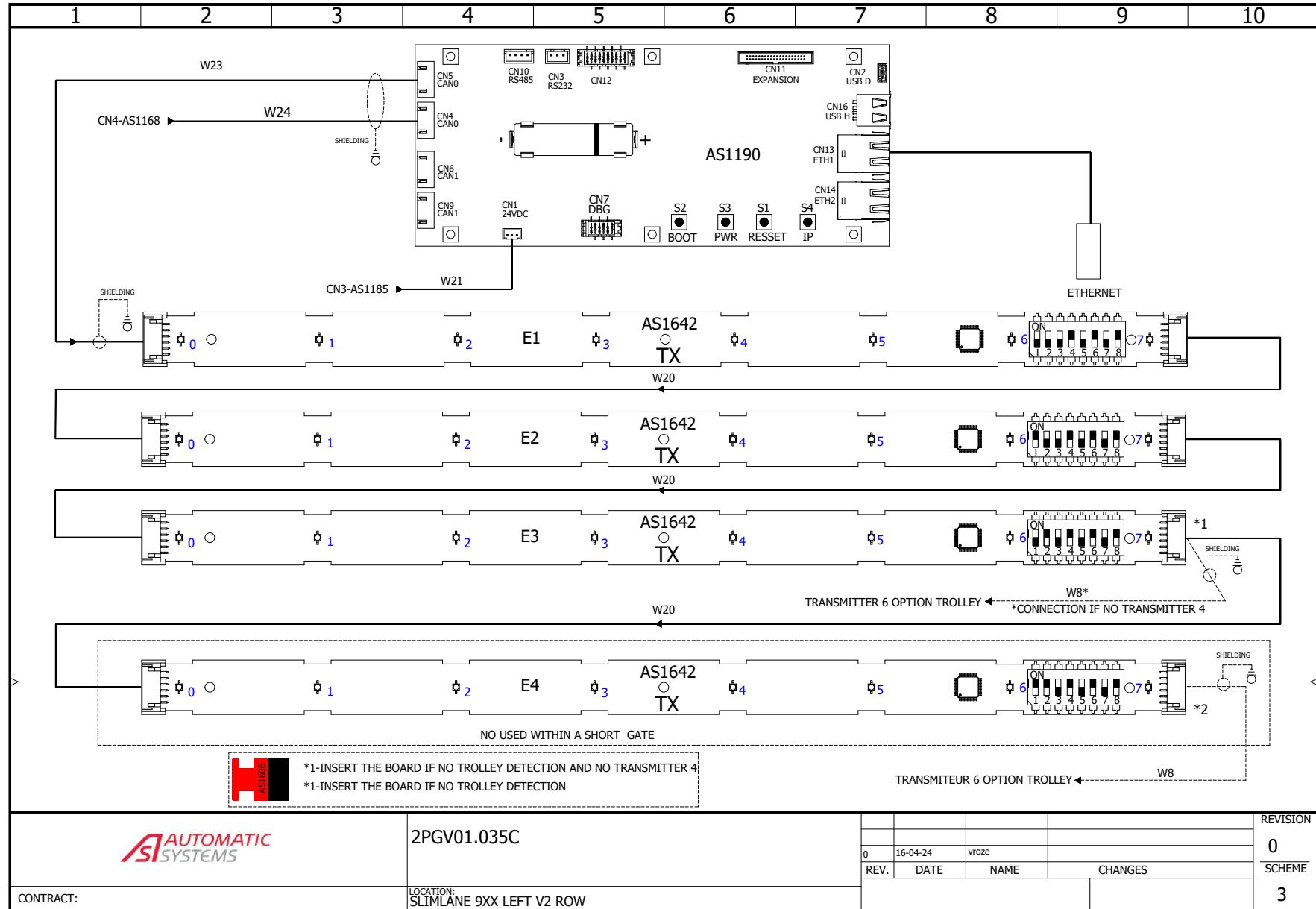

SLIMLANE - GLASS SWING GATES

ENGLISH

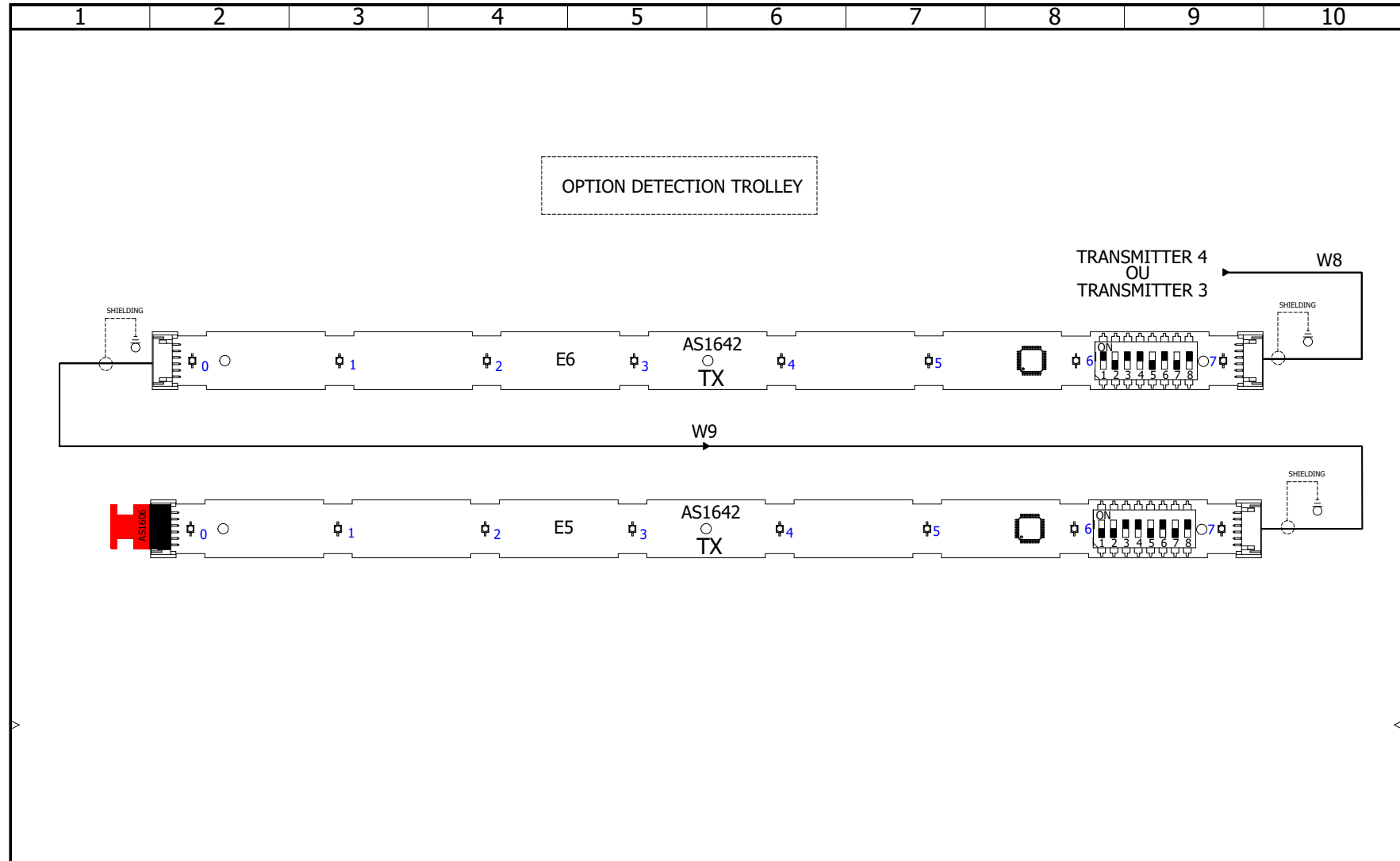

	2PGV01.035D				REVISION
					0
CONTRACT:	LOCATION: SLIMLANE 9XX LEFT V2 ROW	0	16-04-24	vroze	SCHEME
		REV.	DATE	NAME	
					4

Document realized with version : 2021.0.5.7

SLIMLANE - GLASS SWING GATES

ENGLISH

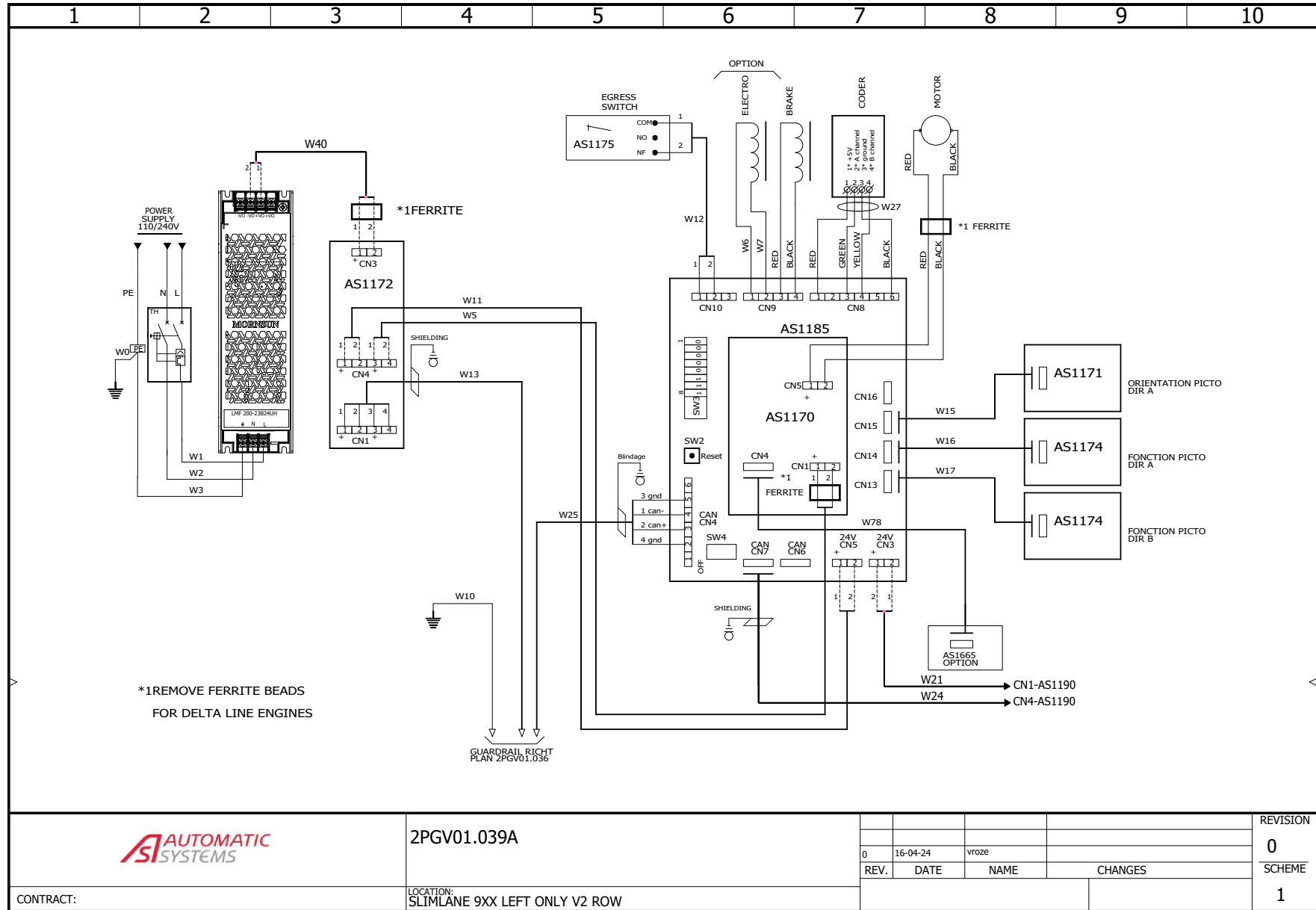

SLIMLANE - GLASS SWING GATES

ENGLISH

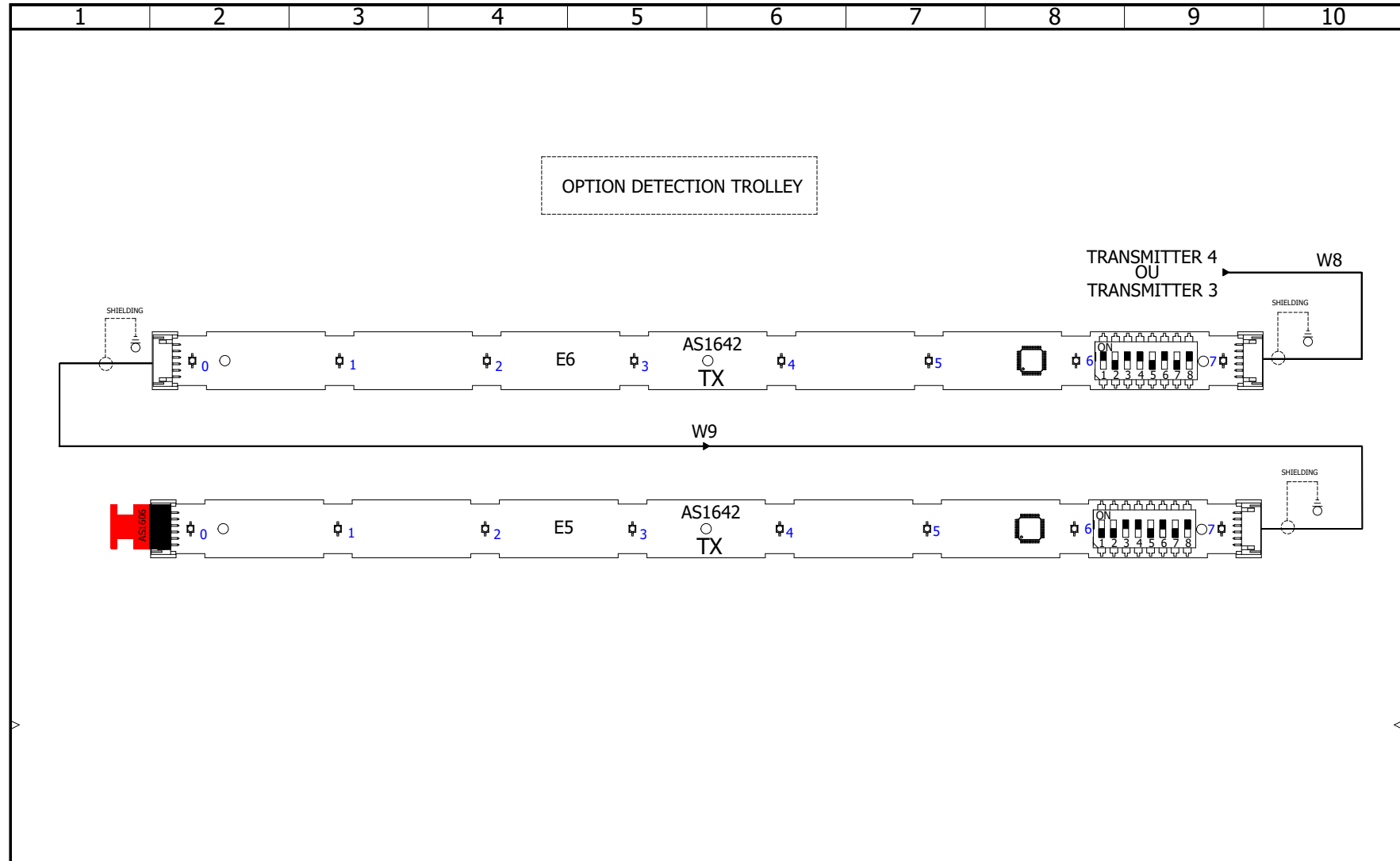

	2PGV01.039C				REVISION
					0
CONTRACT:	LOCATION: SLIMLANE 9XX LEFT ONLY V2 ROW	0	16-04-24	vroze	SCHEME
		REV.	DATE	NAME	CHANGES

Document realized with version : 2021.01.5.7

SLIMLANE - GLASS SWING GATES

ENGLISH

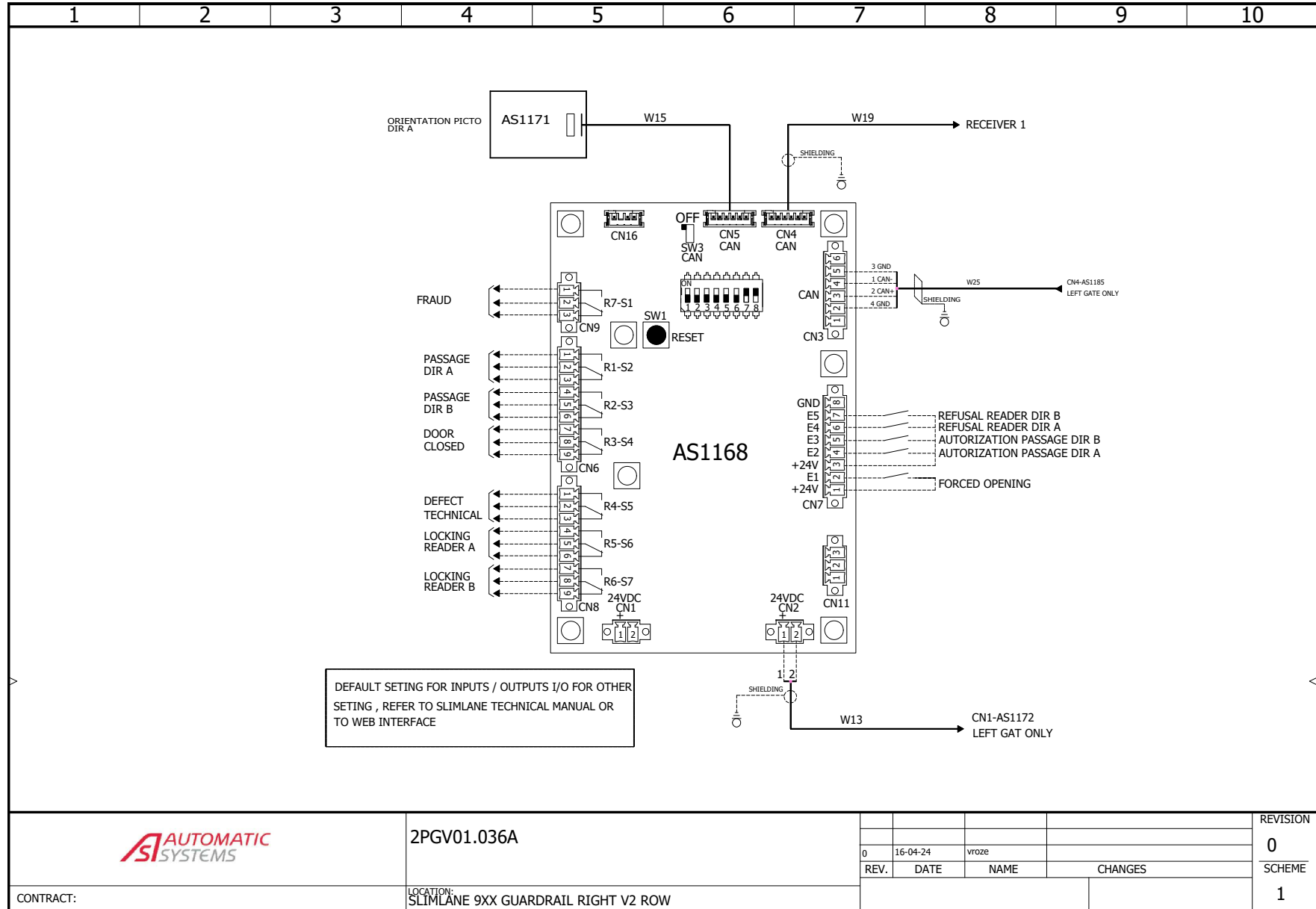

2PGV01.036A

CONTRACT:

LOCATION:
SLIMLANE 9XX GUARDRAIL RIGHT V2 ROW

REV.	DATE	NAME	CHANGES	REVISION
0	16-04-24	vroze		0
				SCHEME
				1

SLIMLANE - GLASS SWING GATES

ENGLISH

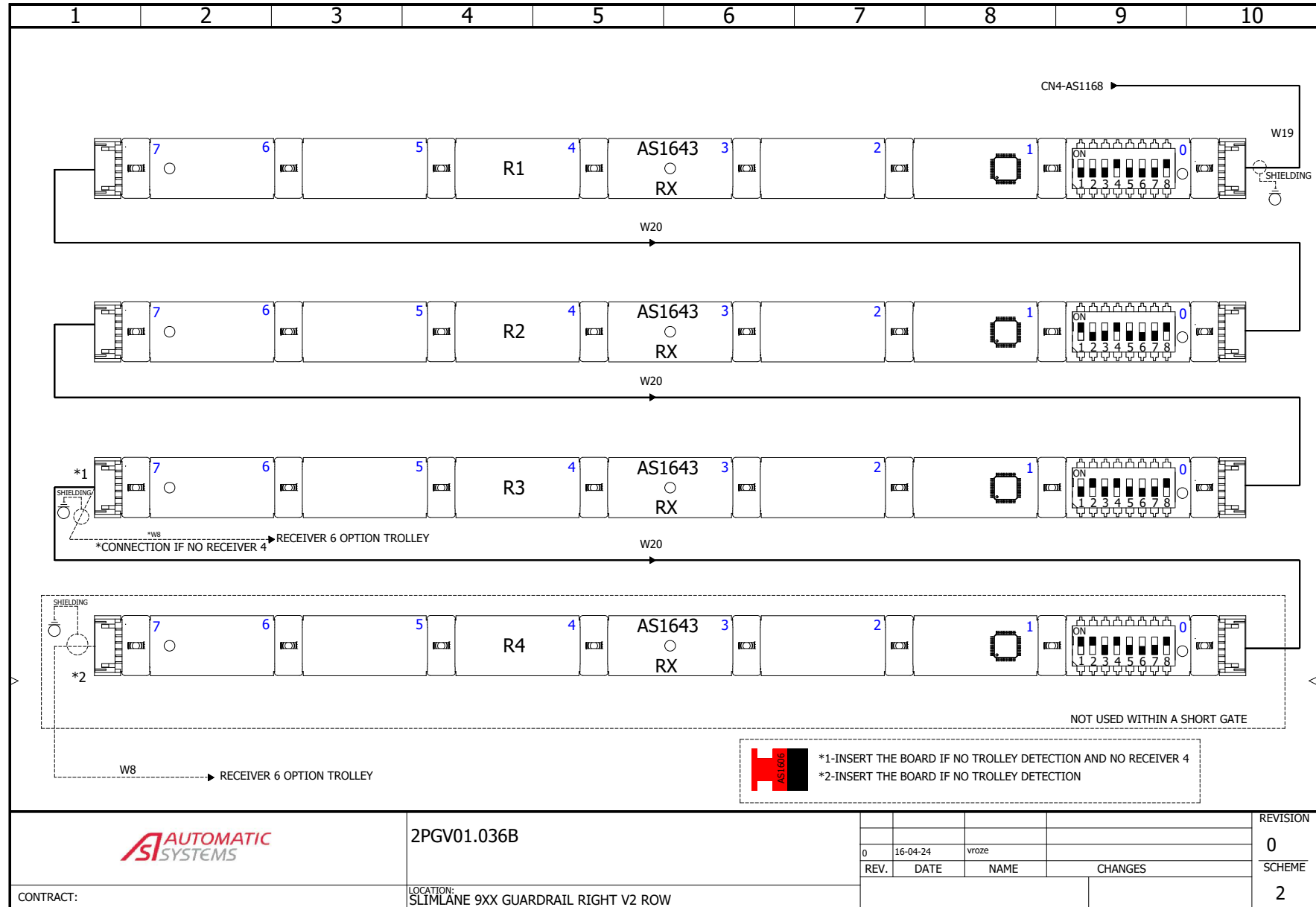

SLIMLANE - GLASS SWING GATES

ENGLISH

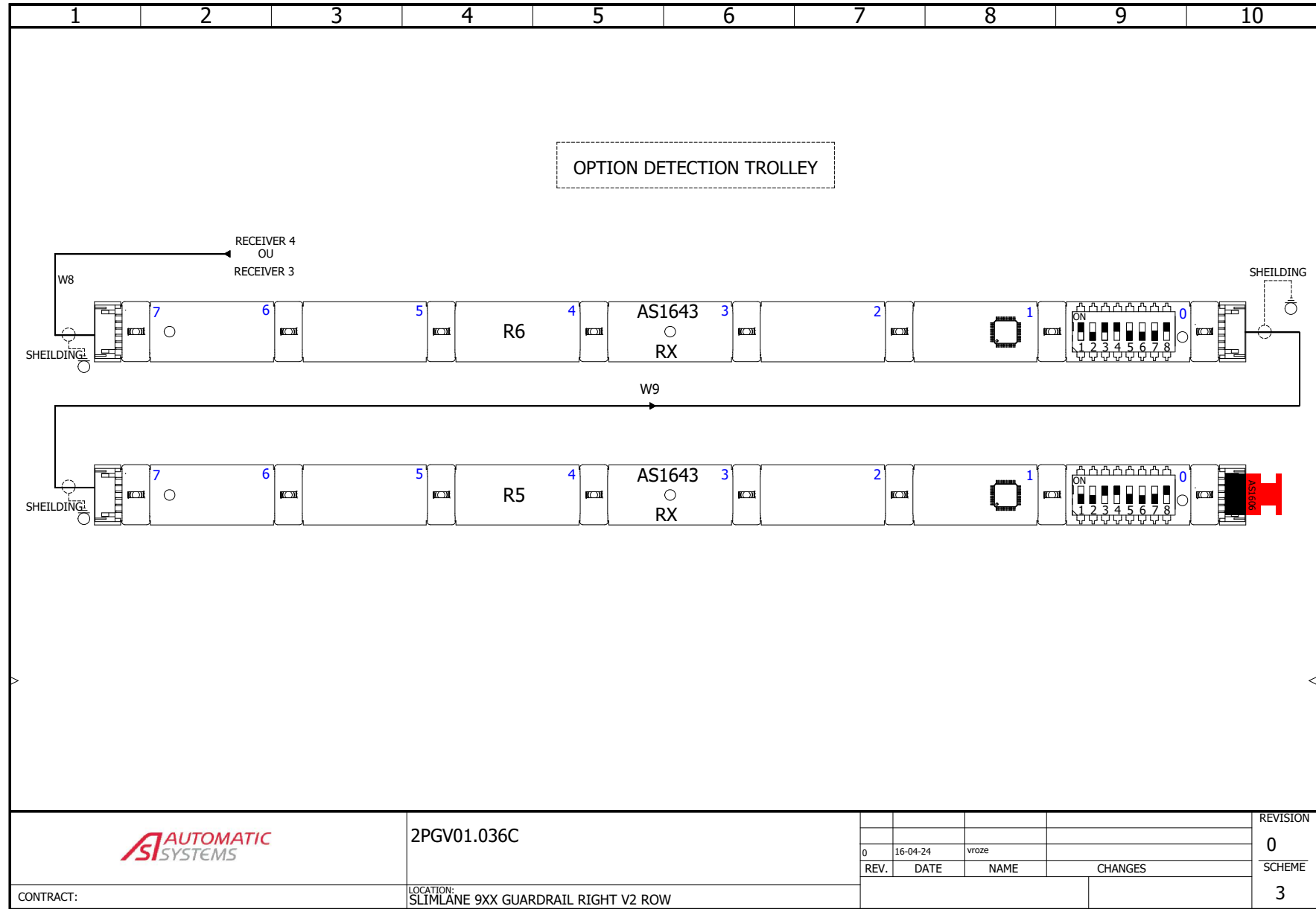

Document realized with version : 2021.0.5.7

SLIMLANE - GLASS SWING GATES

ENGLISH

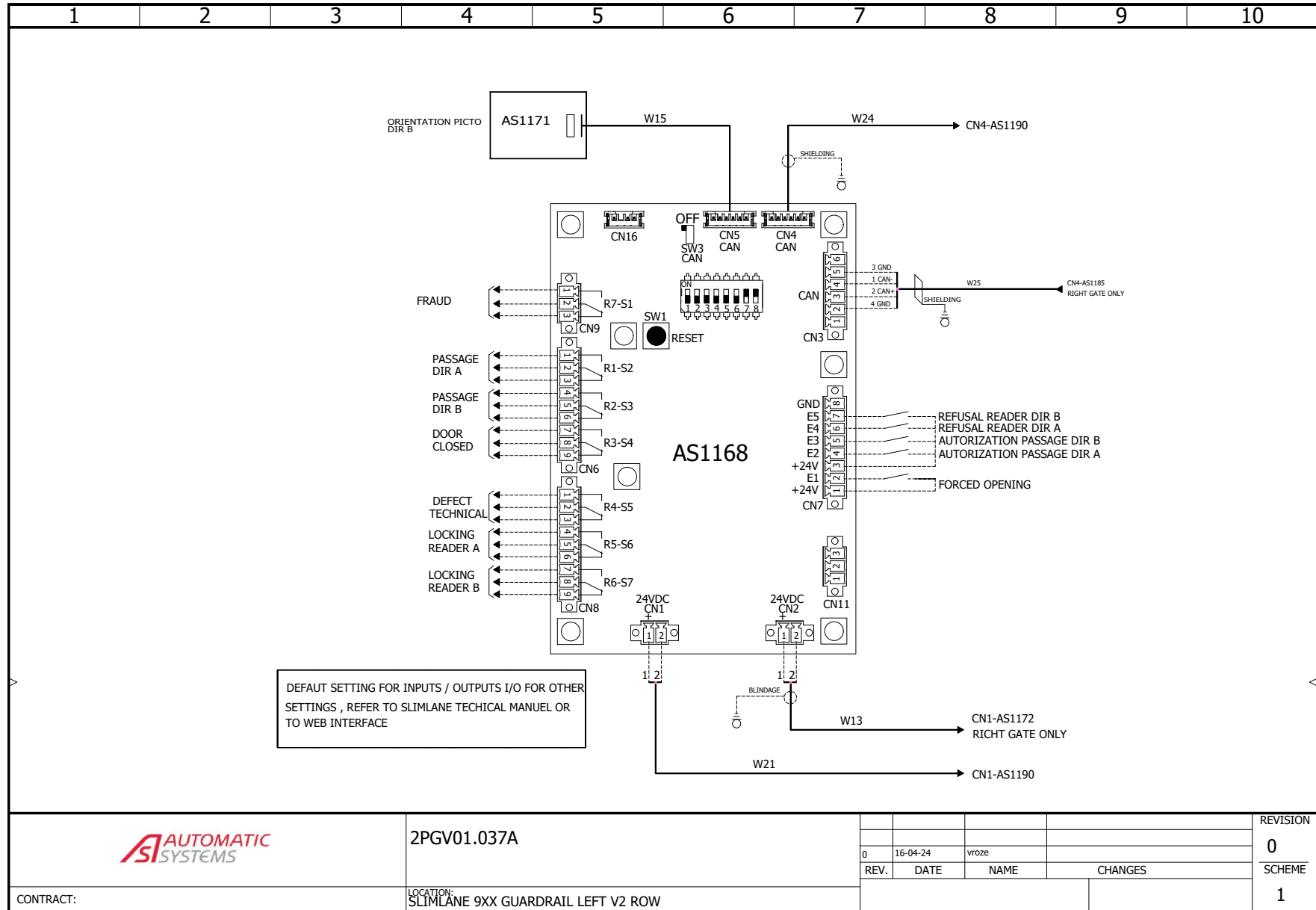

2PGV01.037A

CONTRACT:

LOCATION:
SLIMLANE 9XX GUARDRAIL LEFT V2 ROW

REV.	DATE	NAME	CHANGES	REVISION
0	16-04-24	vroze		0
				SCHEME
				1

SLIMLANE - GLASS SWING GATES

ENGLISH

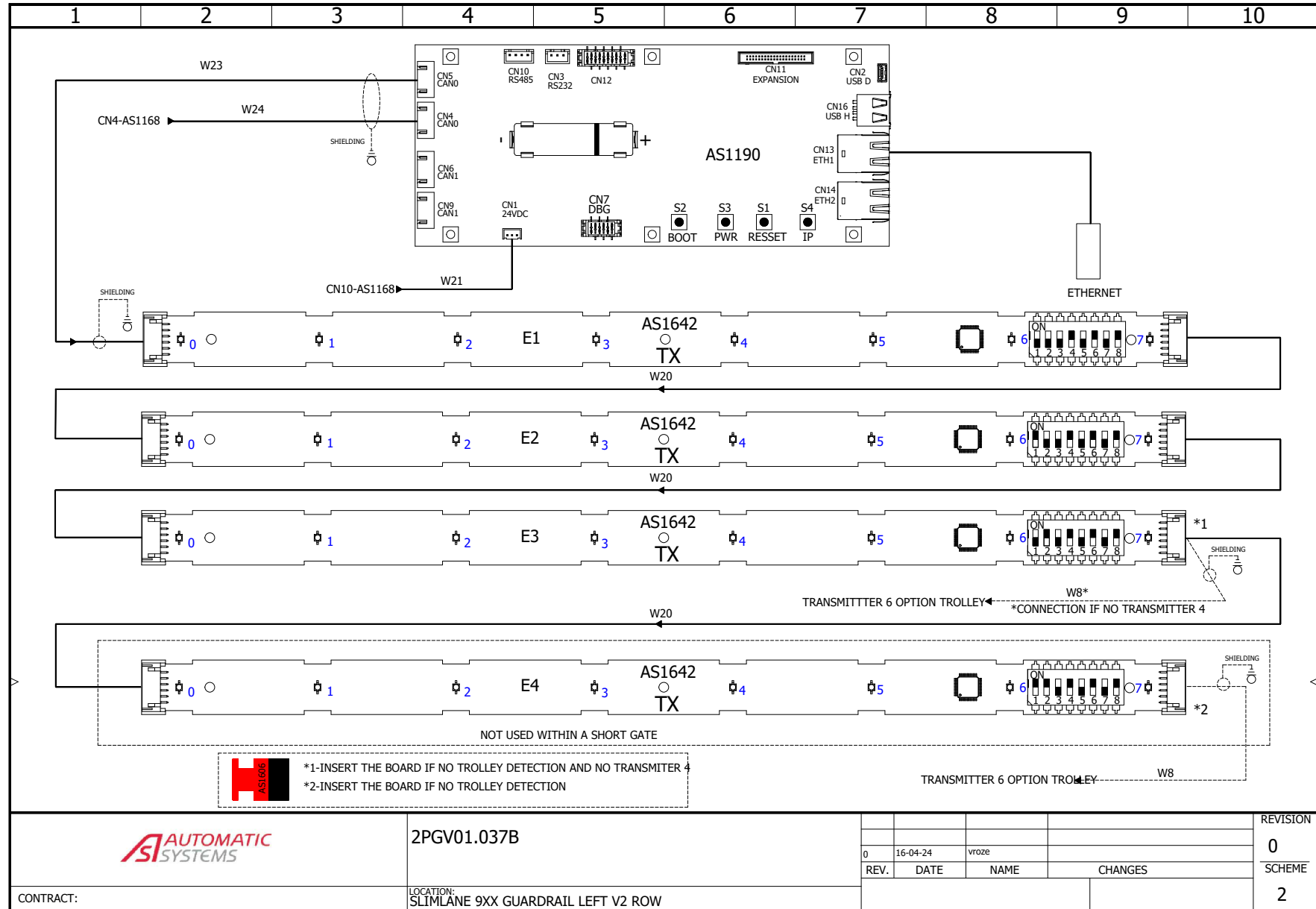

2PGV01.037B

CONTRACT:

LOCATION:
SLIMLANE 9XX GUARDRAIL LEFT V2 ROW

REV.	DATE	NAME	CHANGES	REVISION
0	16-04-24	vroze		0
				SCHEME
				2

SLIMLANE - GLASS SWING GATES

ENGLISH

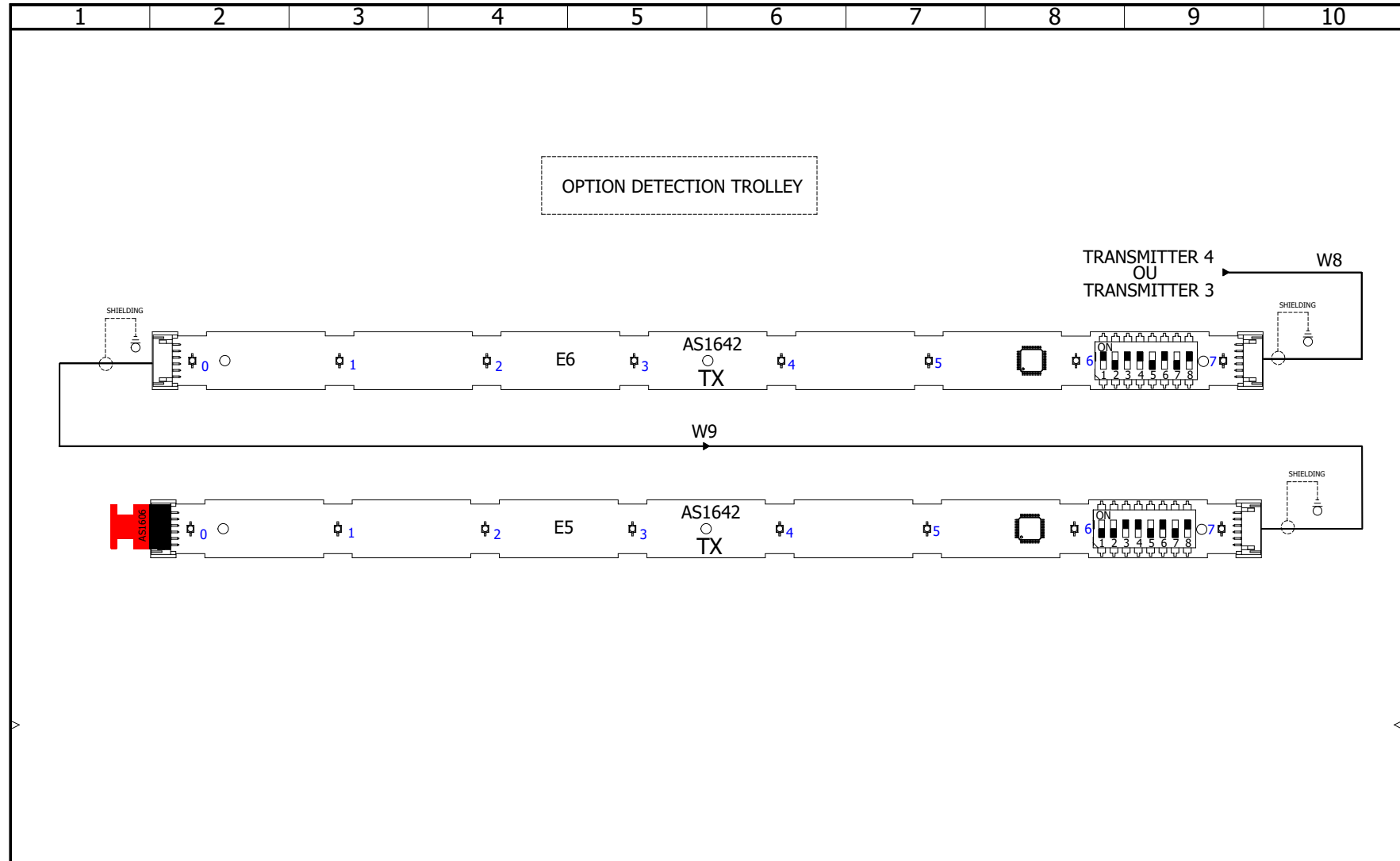

	2PGV01.037C				REVISION
					0
CONTRACT:	LOCATION: SLIMLANE 9XX GUARDRAIL LEFT V2 ROW	0	16-04-24	vroze	SCHEME
		REV.	DATE	NAME	
					3

Document realized with version : 2021.01.5.7

SLIMLANE - GLASS SWING GATES

ENGLISH

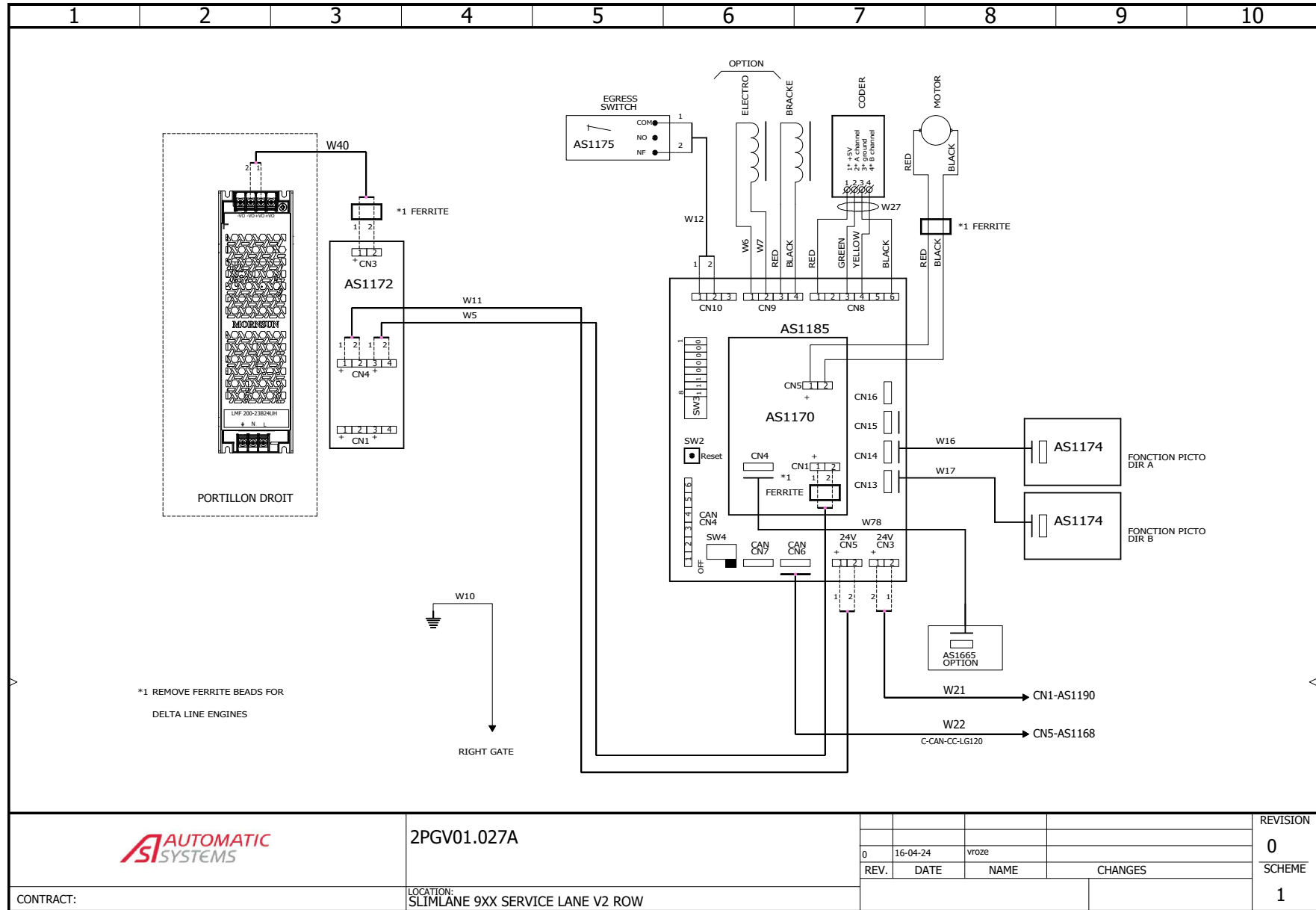

2PGV01.027A

LOCATION: SLIMLANE 9XX SERVICE LANE V2 ROW

REV.	DATE	NAME	CHANGES	REVISION
0	16-04-24	vroze		0
				SCHEME
				1

CONTRACT:

Document realized with version : 2021.0.5.7

SLIMLANE - GLASS SWING GATES

ENGLISH

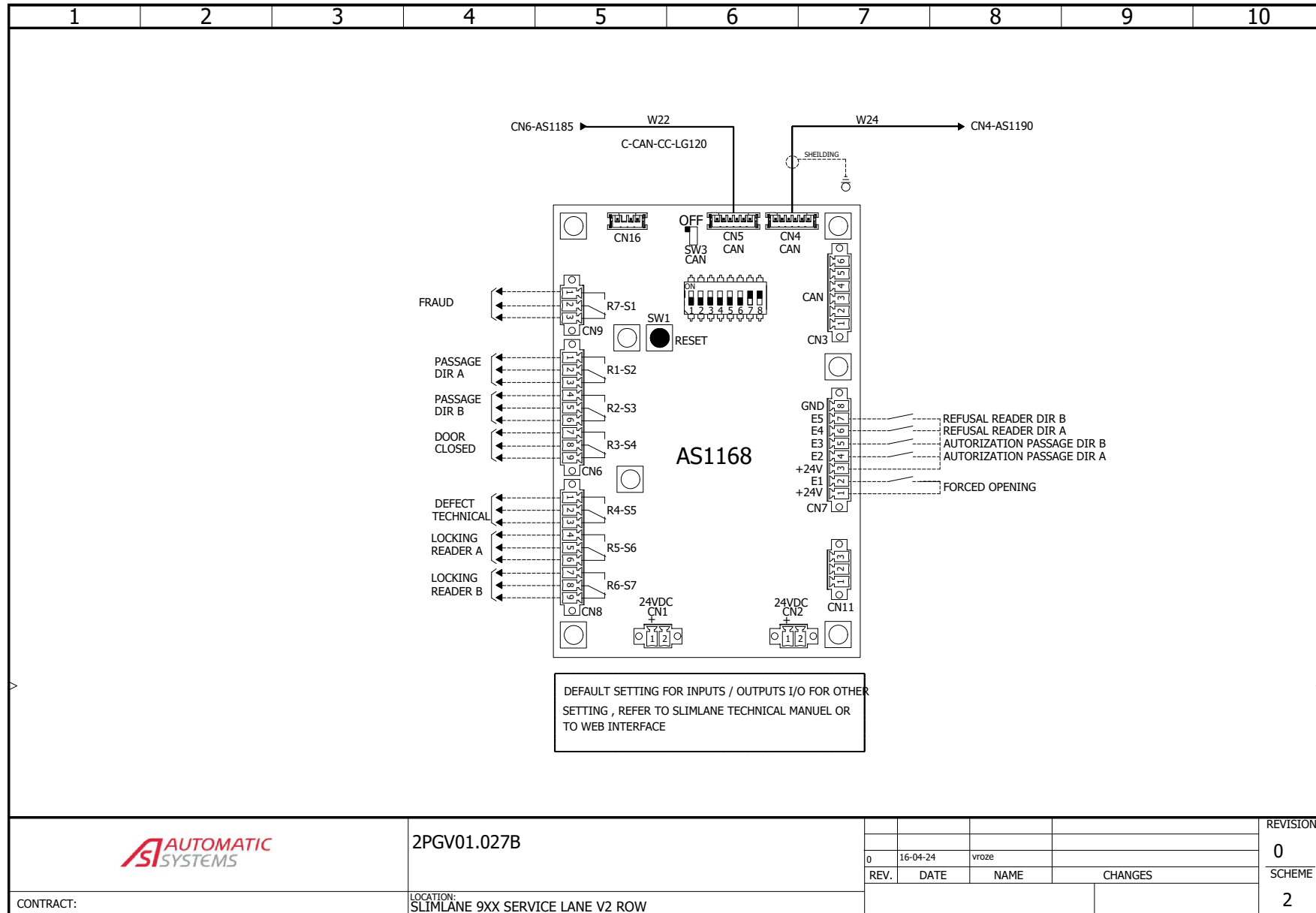

SLIMLANE - GLASS SWING GATES

ENGLISH

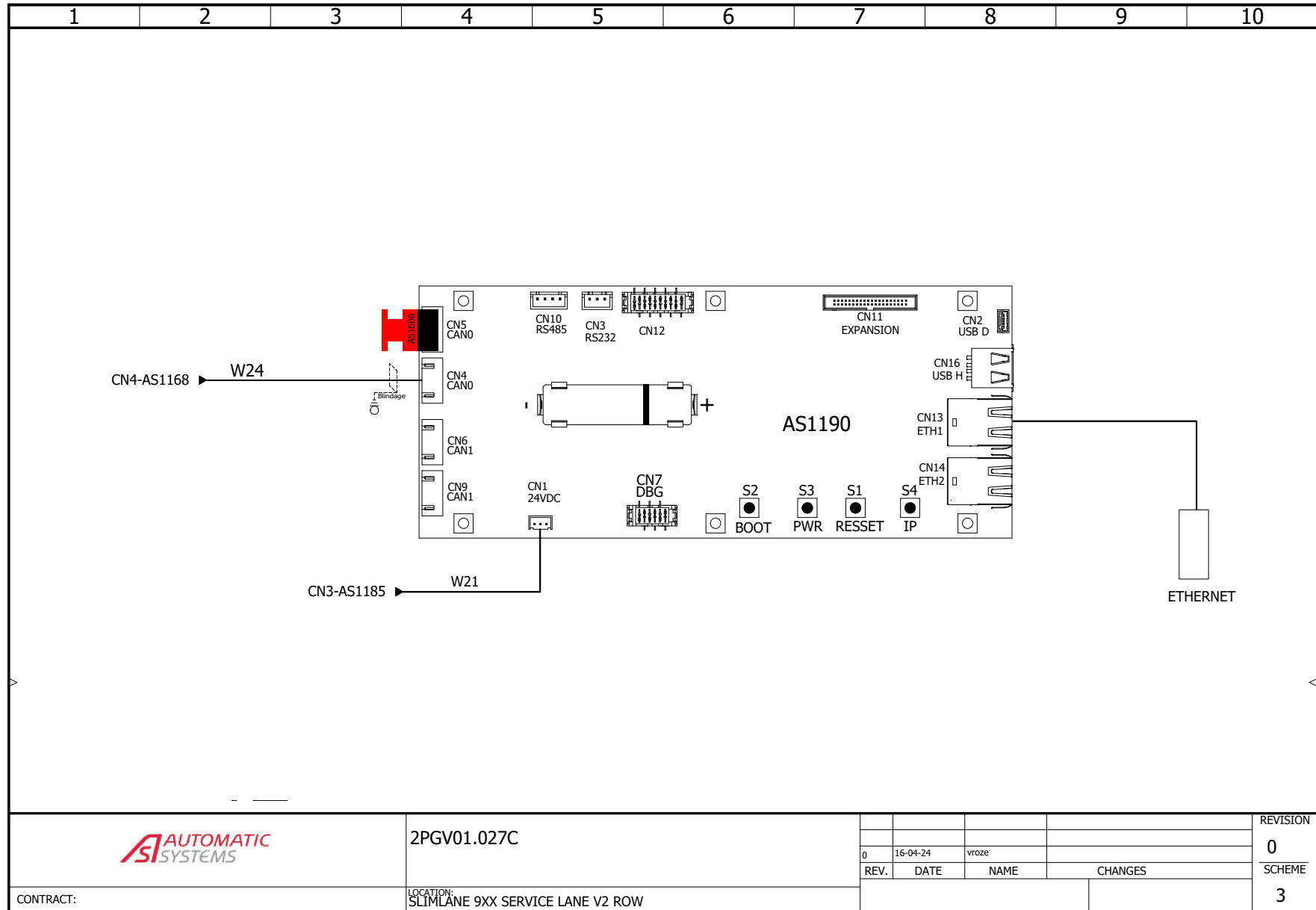

SLIMLANE - GLASS SWING GATES

ENGLISH

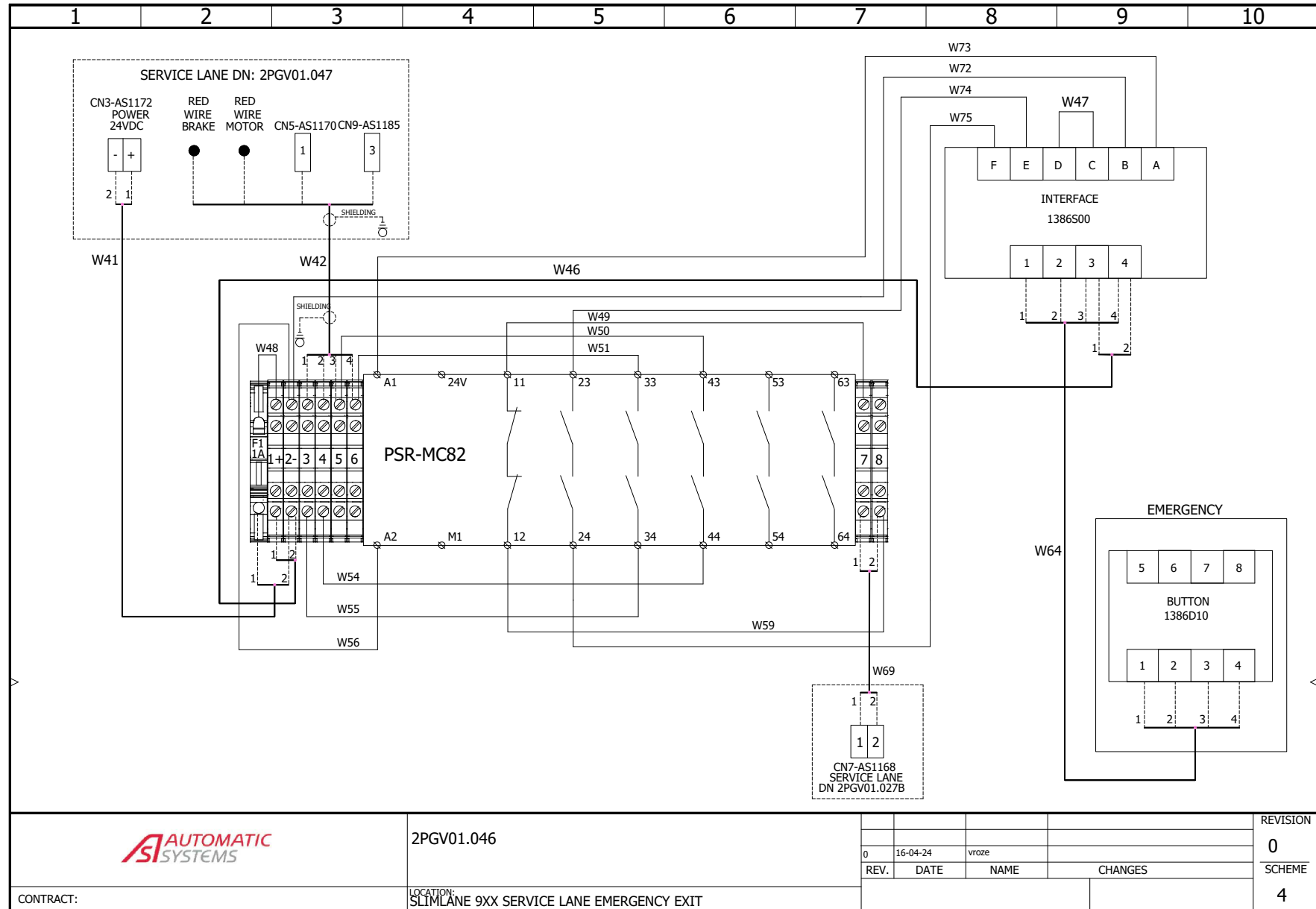

2PGV01.046

CONTRACT:

LOCATION:
SLIMLANE 9XX SERVICE LANE EMERGENCY EXIT

REV.	DATE	NAME	CHANGES	REVISION
0	16-04-24	vroze		0
				SCHEME
				4

SLIMLANE - GLASS SWING GATES

ENGLISH

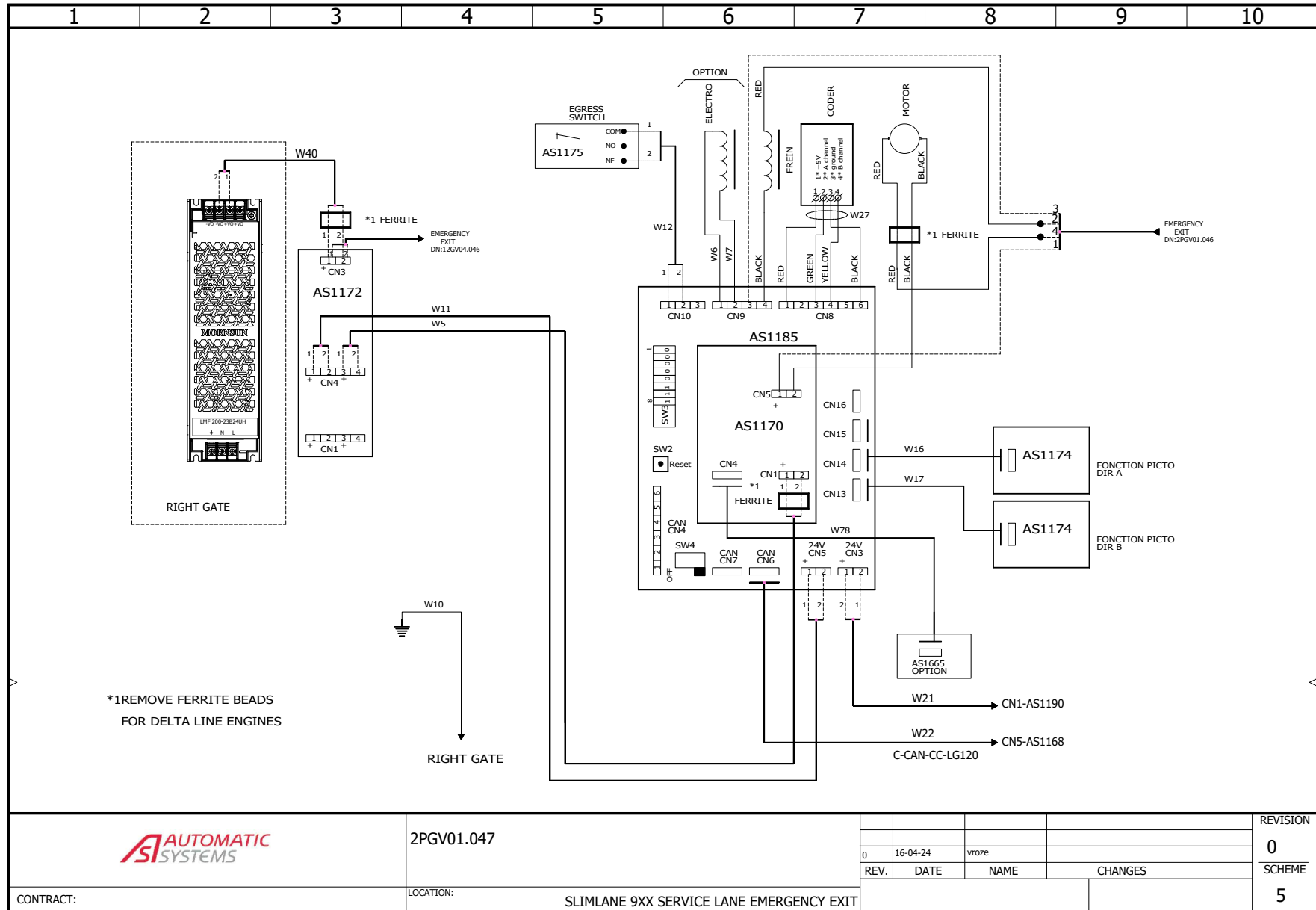

SLIMLANE - GLASS SWING GATES

ENGLISH

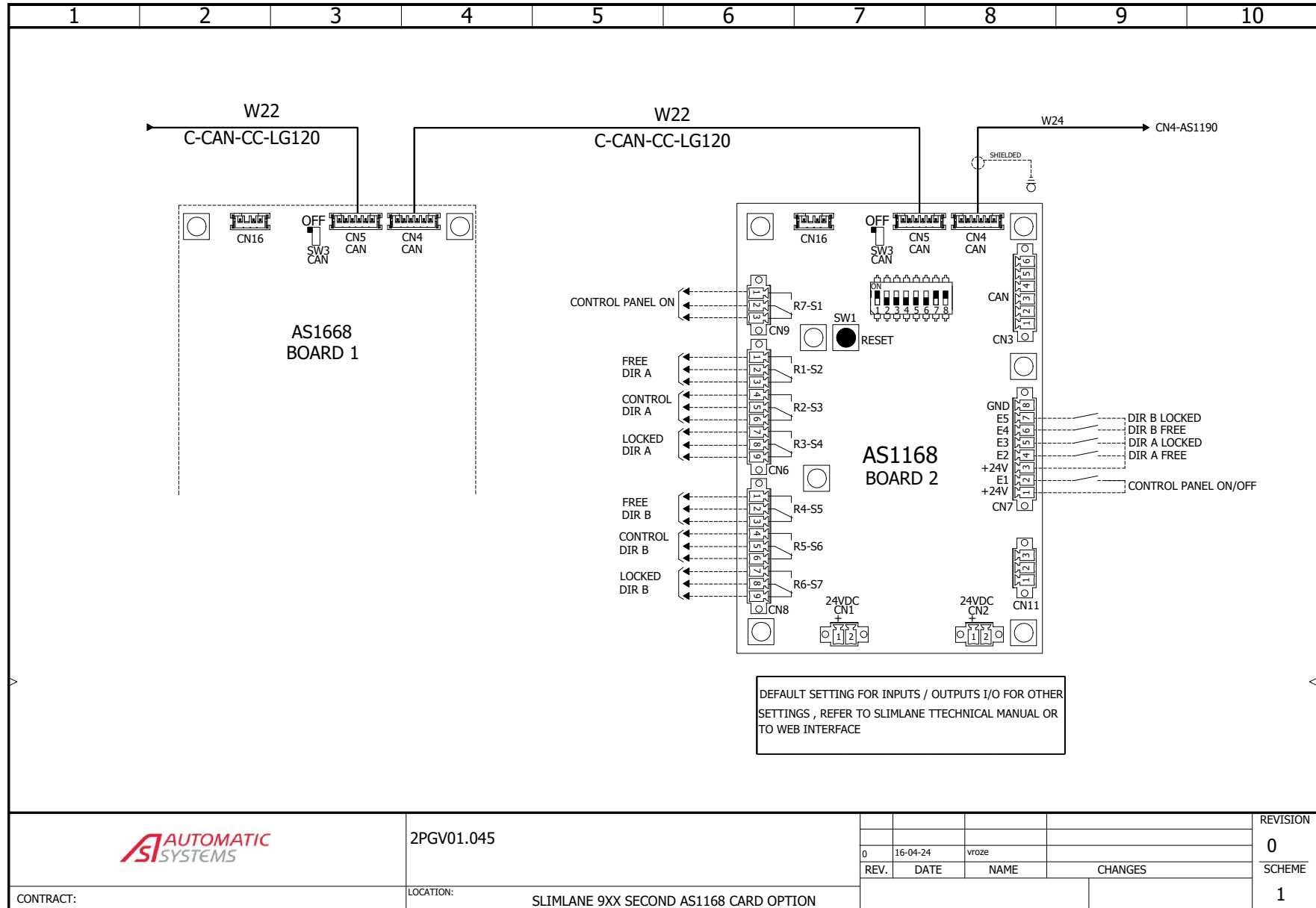

SLIMLANE - GLASS SWING GATES

ENGLISH

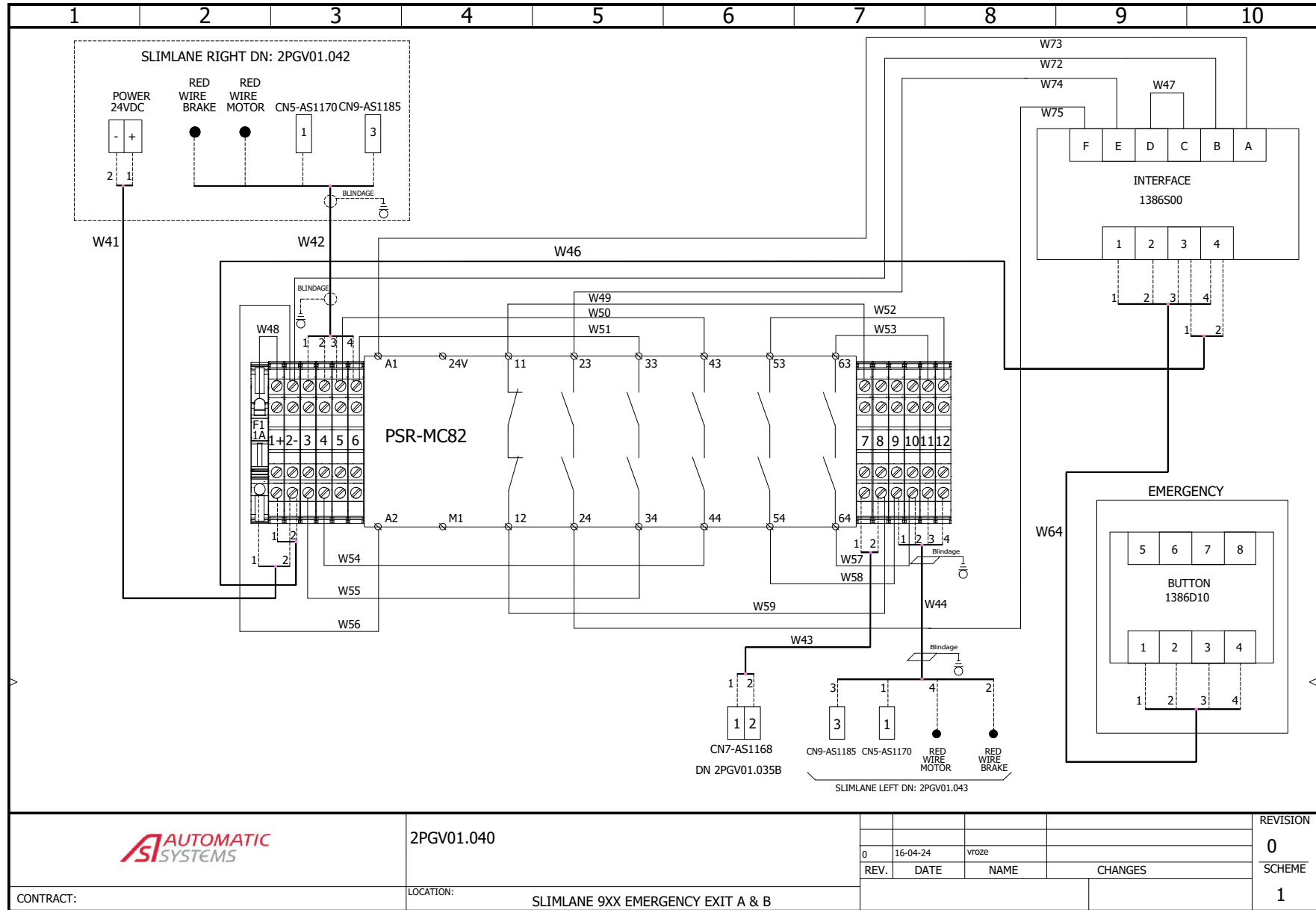

2PGV01.040

REV.	DATE	NAME	CHANGES	REVISION
0	16-04-24	vroze		0
				SCHEME
				1

CONTRACT:

LOCATION:

SLIMLANE 9XX EMERGENCY EXIT A & B

SLIMLANE - GLASS SWING GATES

ENGLISH

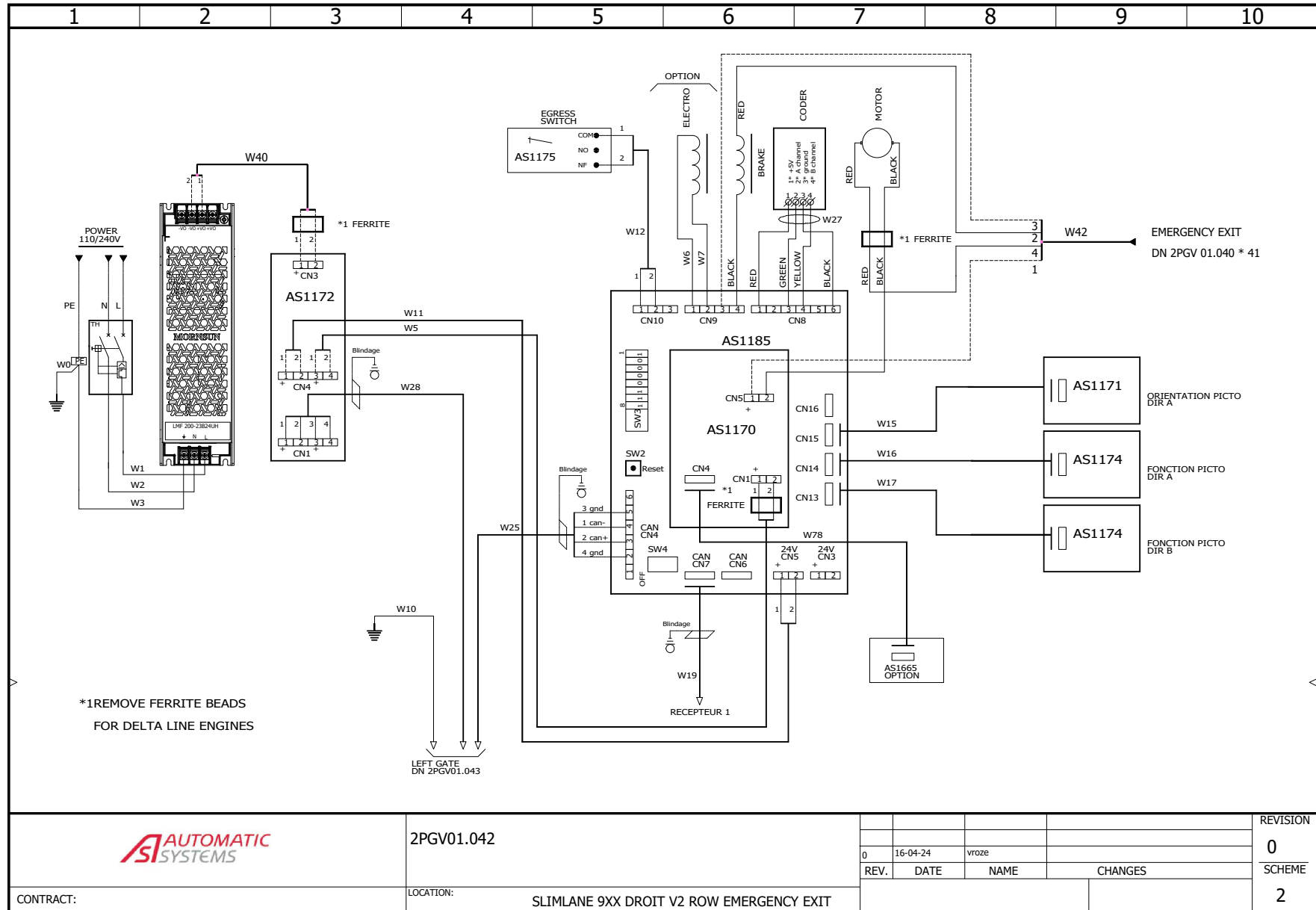

SLIMLANE - GLASS SWING GATES

ENGLISH

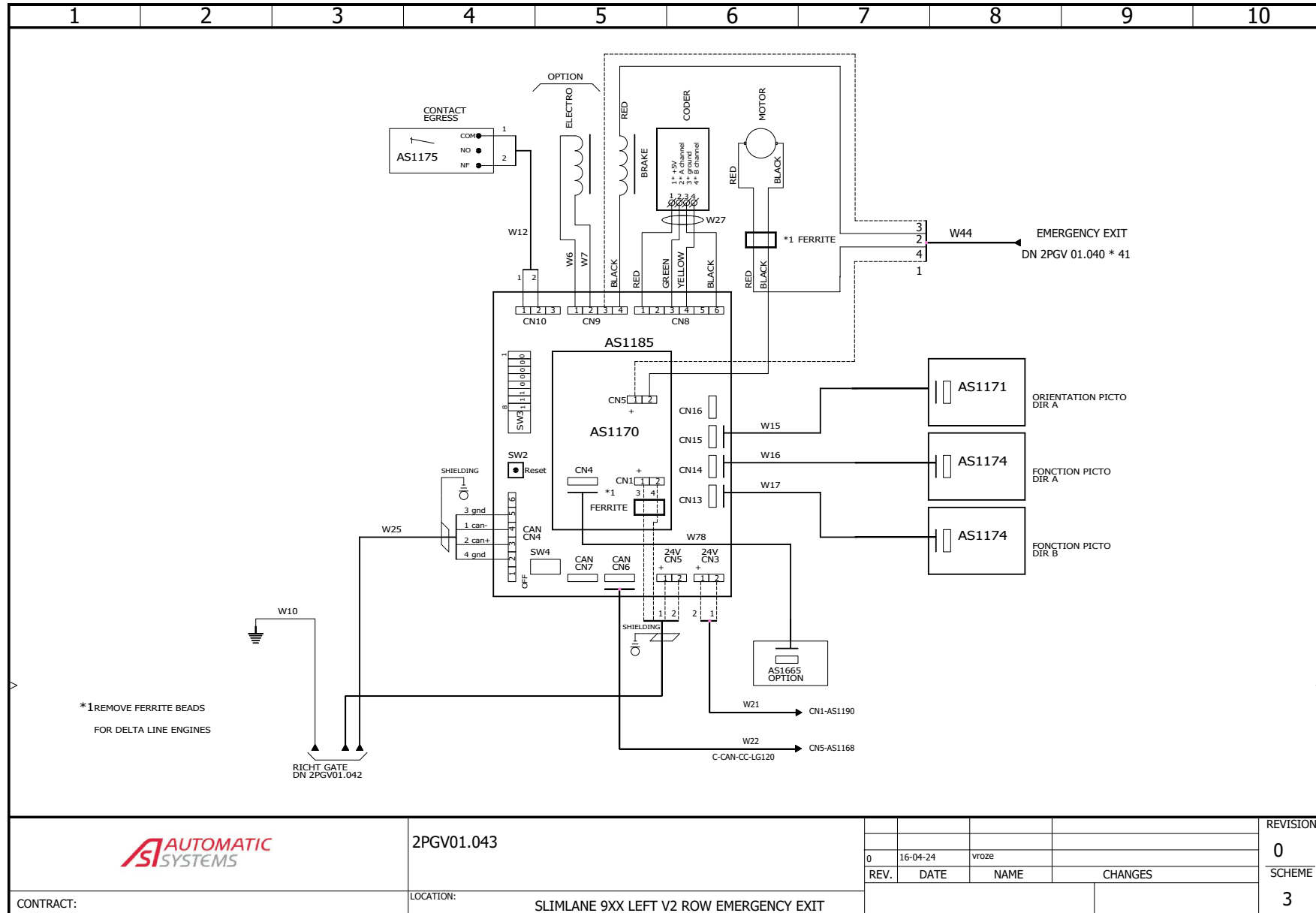

2PGV01.043

CONTRACT:

LOCATION:

SLIMLANE 9XX LEFT V2 ROW EMERGENCY EXIT

REV.	DATE	NAME	CHANGES	REVISION
0	16-04-24	vroze		0
				SCHEME
				3

SLIMLANE - GLASS SWING GATES

ENGLISH

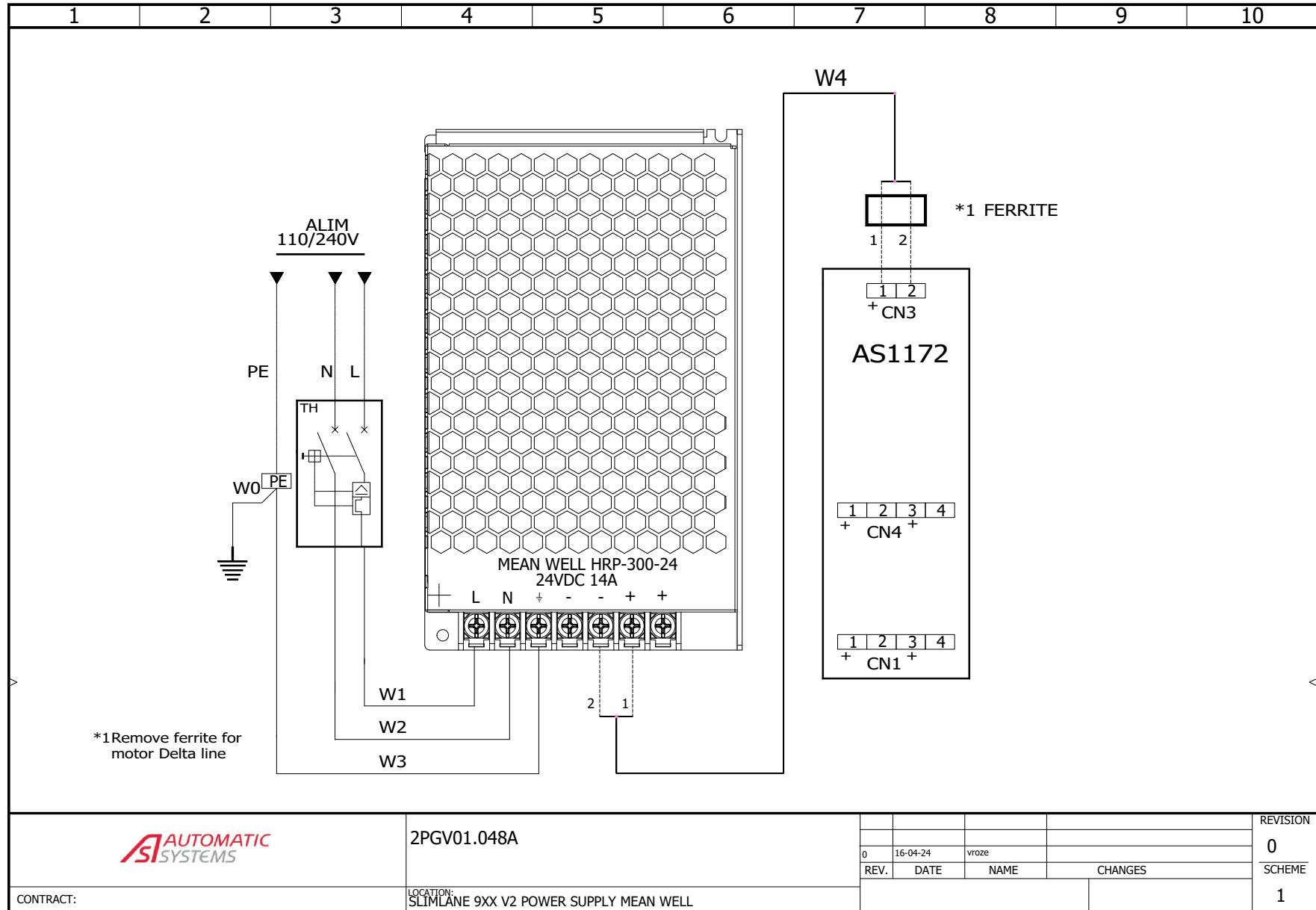



BUREAUX BELGES ET INTERNATIONAUX

 Belgique
Tel.: +32.(0)10.23.02.11
helpdesk.as@automatic-systems.com

 France
Tel.: +33 1 30 28 95 53
helpdesk.fr@automatic-systems.com

 Allemagne
Tel.: +49 2303 553 4040
helpdesk.de@automatic-systems.com

 Royaume-Uni
Tel.: +44 (0) 1604 654 210
helpdesk.uk@automatic-systems.com

 Espagne
Tel.: +34 93 478 77 55
helpdesk.es@automatic-systems.com

 États-Unis et Canada
Tel.: +1 450 659 0737
helpdesk.nam@automatic-systems.com

 Autres pays
Tel.: +32.(0)10.23.02.11
helpdesk.as@automatic-systems.com

SlimLane-DTE-03



Headquarters 
Avenue Mercator, 5
1300 Wavre - Belgium

www.automatic-systems.com 