

SECURE GATES

Lösningar för kunder med krav

**AUTOMATIC
SYSTEMS**

FI FirstLane™

EN



FIRSTLANE FL9X3

Rév. 03 • Mise à jour 04/2024



www.automatic-systems.com

ATTENTION!

THE FOLLOWING ARE INCLUDED IN THIS ELECTRICAL TECHNICAL FILE:

- **ALL ELECTRICAL DIAGRAMS OF STANDARD PRODUCTS**
- **ELECTRICAL DIAGRAMS FOR THE EMERGENCY OPENING BUTTON OPTION**
- **ELECTRICAL DIAGRAMS FOR THE HEATING OPTION**

ATTENTION!

FOR ANY OTHER TYPE OF OPTION OR CUSTOMISATION PLEASE REFER TO THE SPECIFIC ELECTRICAL TECHNICAL FILE SUPPLIED WITH YOUR EQUIPMENT!

FIRSTLANE FL9X3 - GLASS SWING GATES

ENGLISH

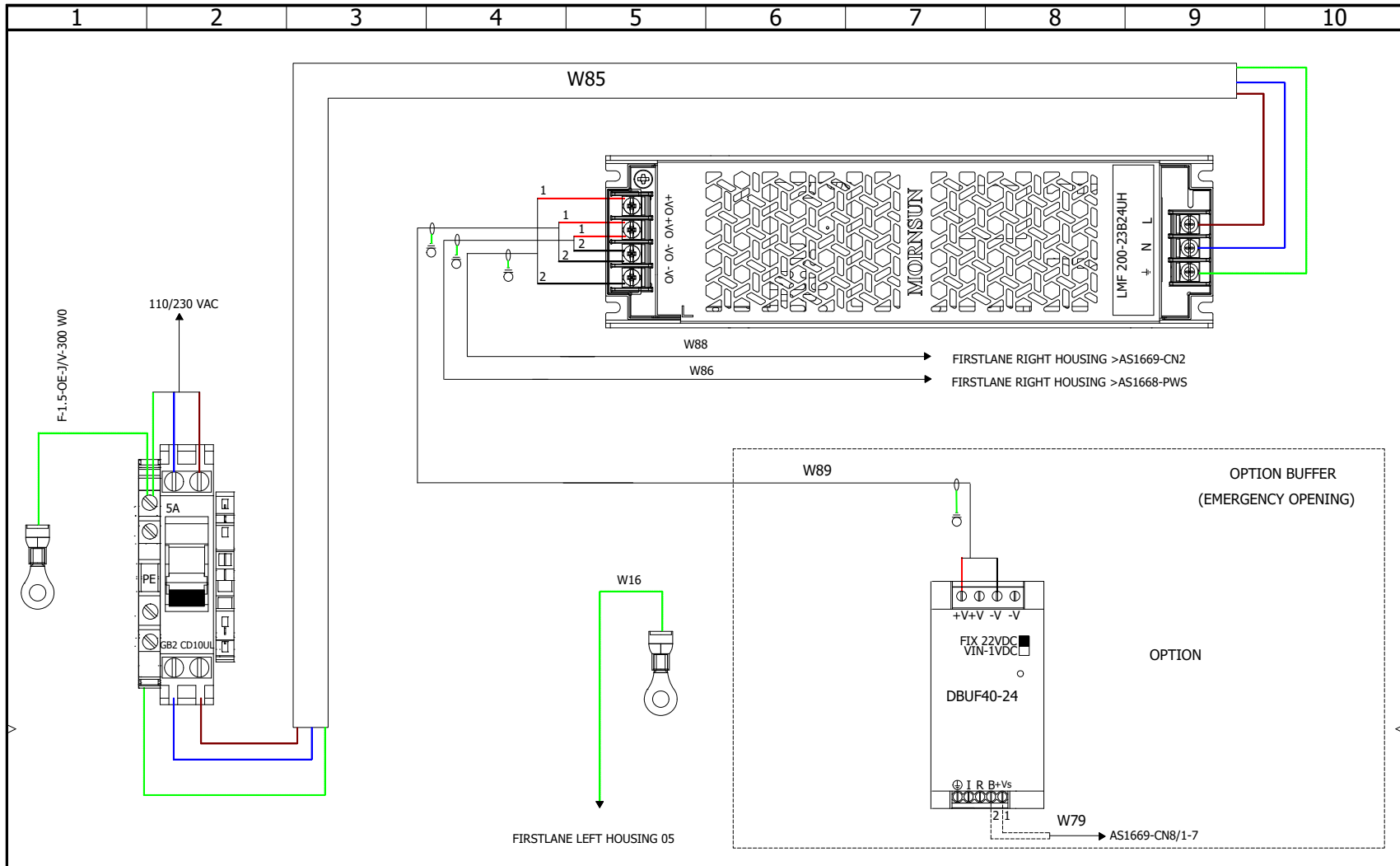

	POWER (UE) ALIM. MORN SUN				REVISION
					4
CONTRACT:	LOCATION: FIRSTLANE V3 EU RIGHT HOUSING	REV.	DATE	NAME	CHANGES
		1	17-04-24	vroze	
					SCHEME
					1

Document realized with version :2021.0.5.7

FIRSTLANE FL9X3 - GLASS SWING GATES

ENGLISH

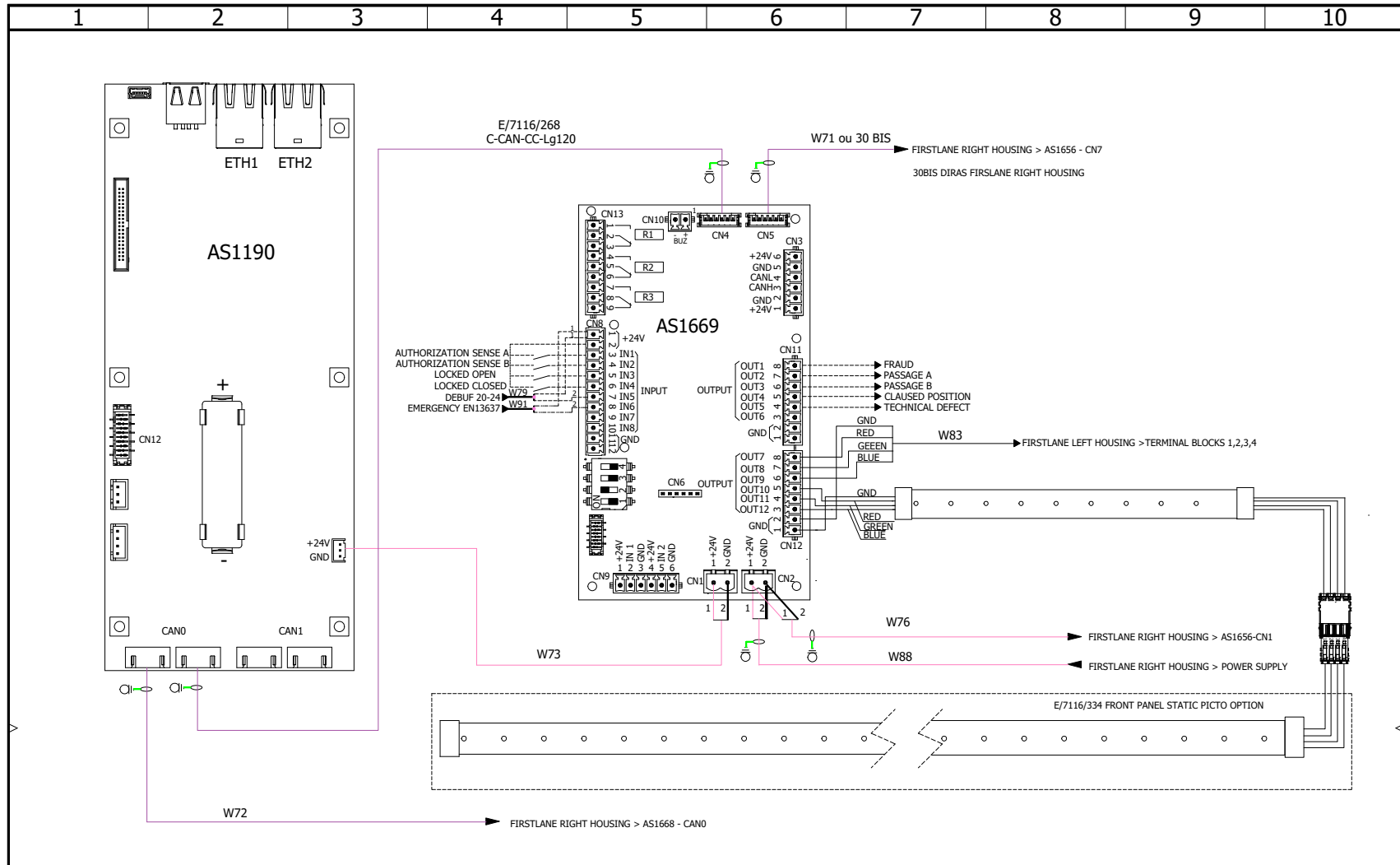



	AS1190 ET 1669				REVISION
					4
CONTRACT:	LOCATION:	FIRSTLANE V3 EU RIGHT HOUSING			SCHEME
					2

Document realized with version :2021.0.5.7

FIRSTLANE FL9X3 - GLASS SWING GATES

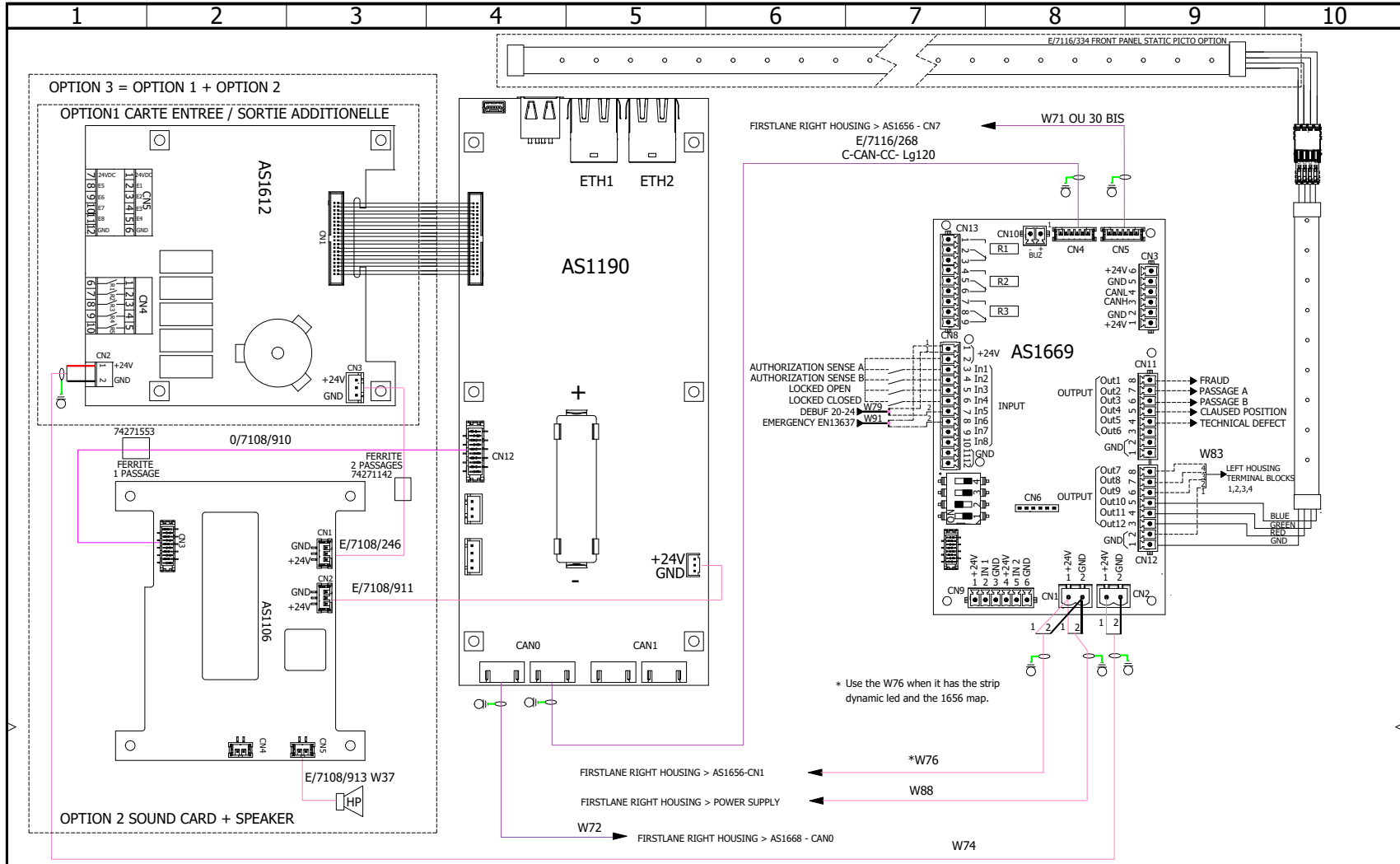
ENGLISH



	AS1190 ET OPTION 1 ET 3 AS1612+AS1106			REVISION
	LOCATION: FIRSTLANE V3 EU RIGHT HOUSING			4
CONTRACT:	REV.	DATE	NAME	CHANGES
	1	17-04-24	vroze	
				SCHEME
				3

Document realized with version : 2021.0.5.7

FIRSTLANE FL9X3 - GLASS SWING GATES

ENGLISH

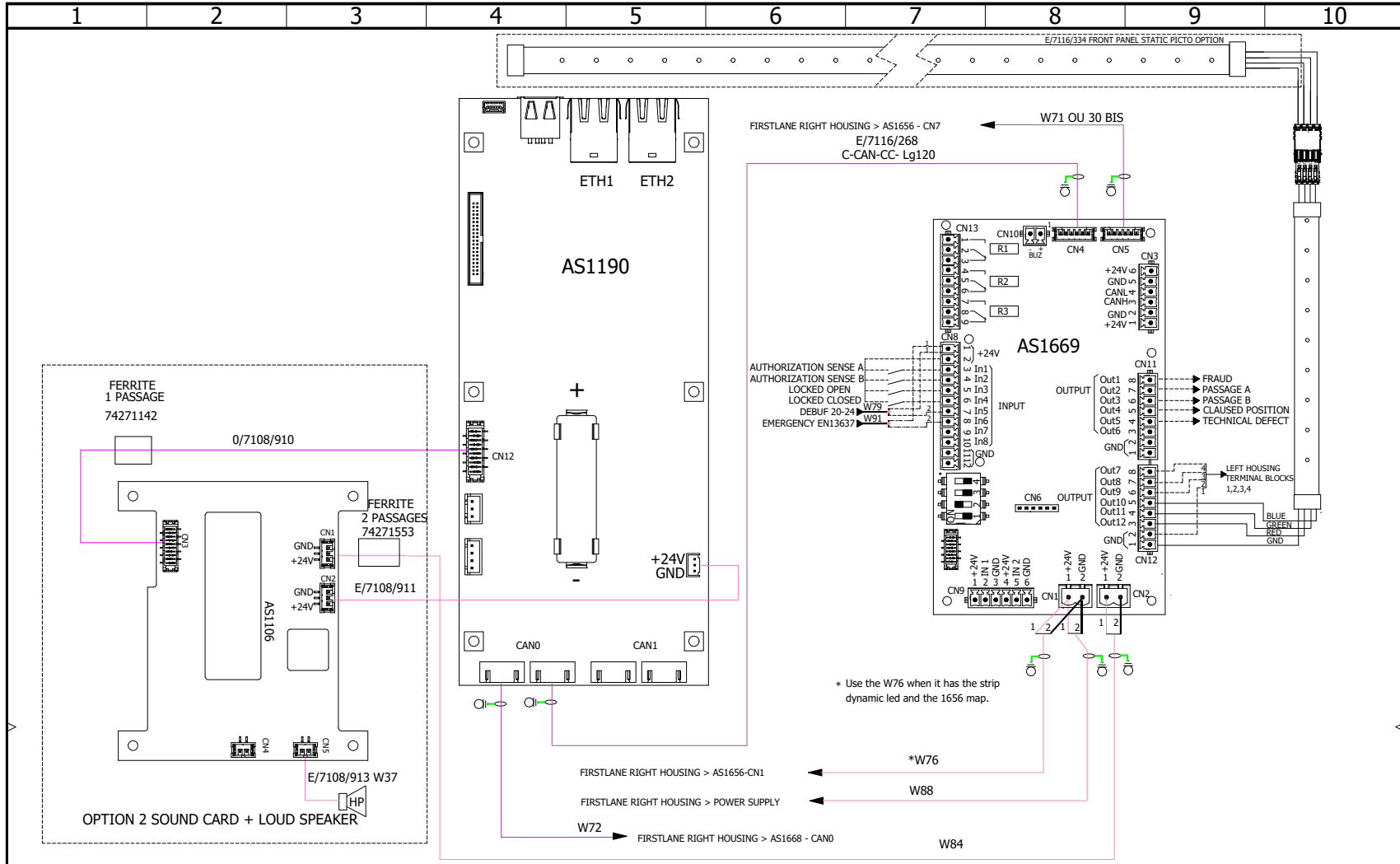

		AS1190 ET OPTION 2 AS1612			REVISION
					4
CONTRACT:	LOCATION:	FIRSTLANE V3 EU RIGHT HOUSING			SCHEME
					4

Document realized with version :2021.0.5.7

FIRSTLANE FL9X3 - GLASS SWING GATES

ENGLISH

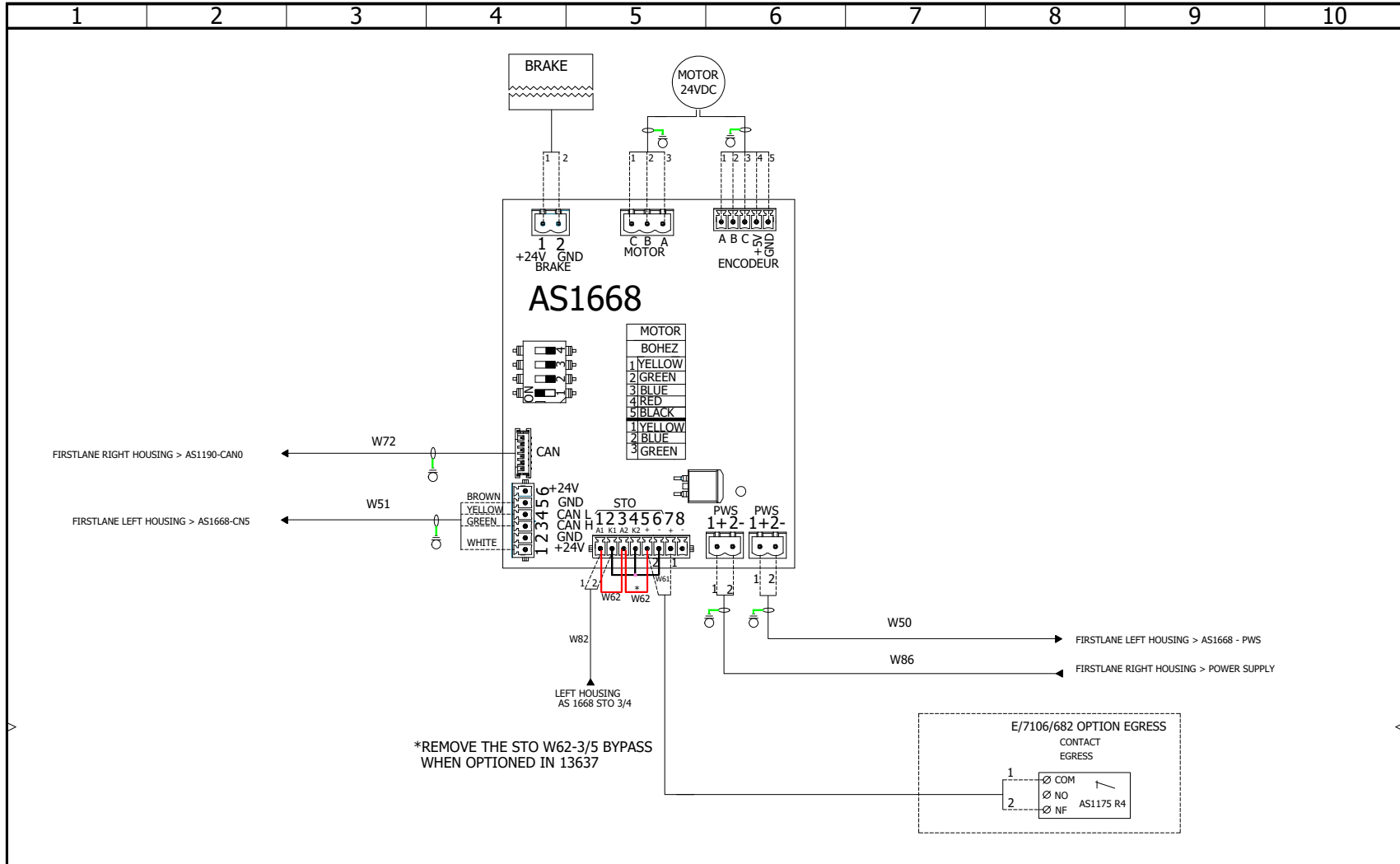

	AS1668			REVISION
				4
CONTRACT:	LOCATION:	FIRSTLANE V3 EU RIGHT HOUSING		SCHEME
				5

Document realized with version :2021.0.5.7

FIRSTLANE FL9X3 - GLASS SWING GATES

ENGLISH

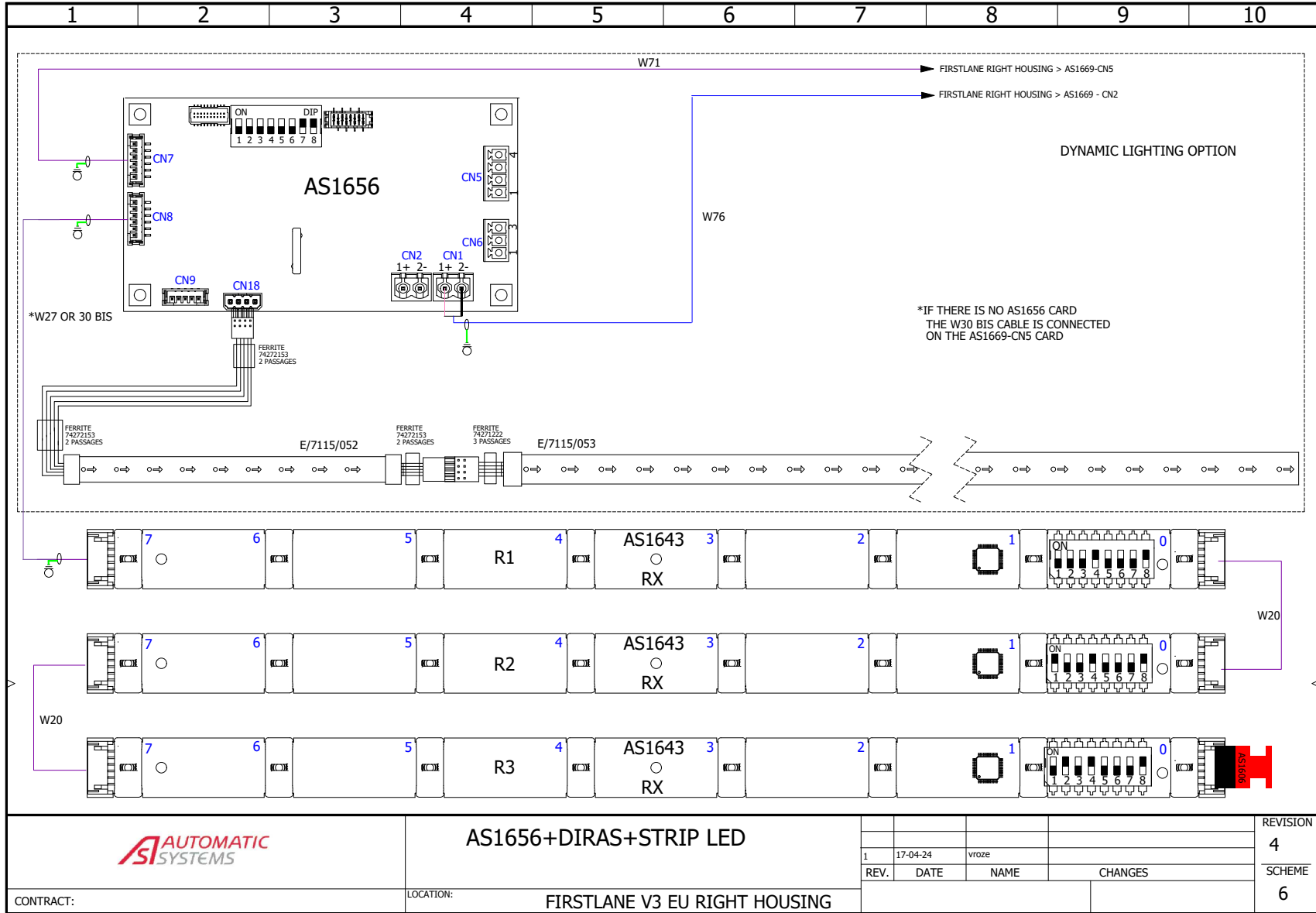

AS1656+DIRAS+STRIP LED

CONTRACT:

LOCATION:

FIRSTLANE V3 EU RIGHT HOUSING

				REVISION
1	17-04-24	vroze		4
REV.	DATE	NAME	CHANGES	SCHEME
				6

FIRSTLANE FL9X3 - GLASS SWING GATES

ENGLISH

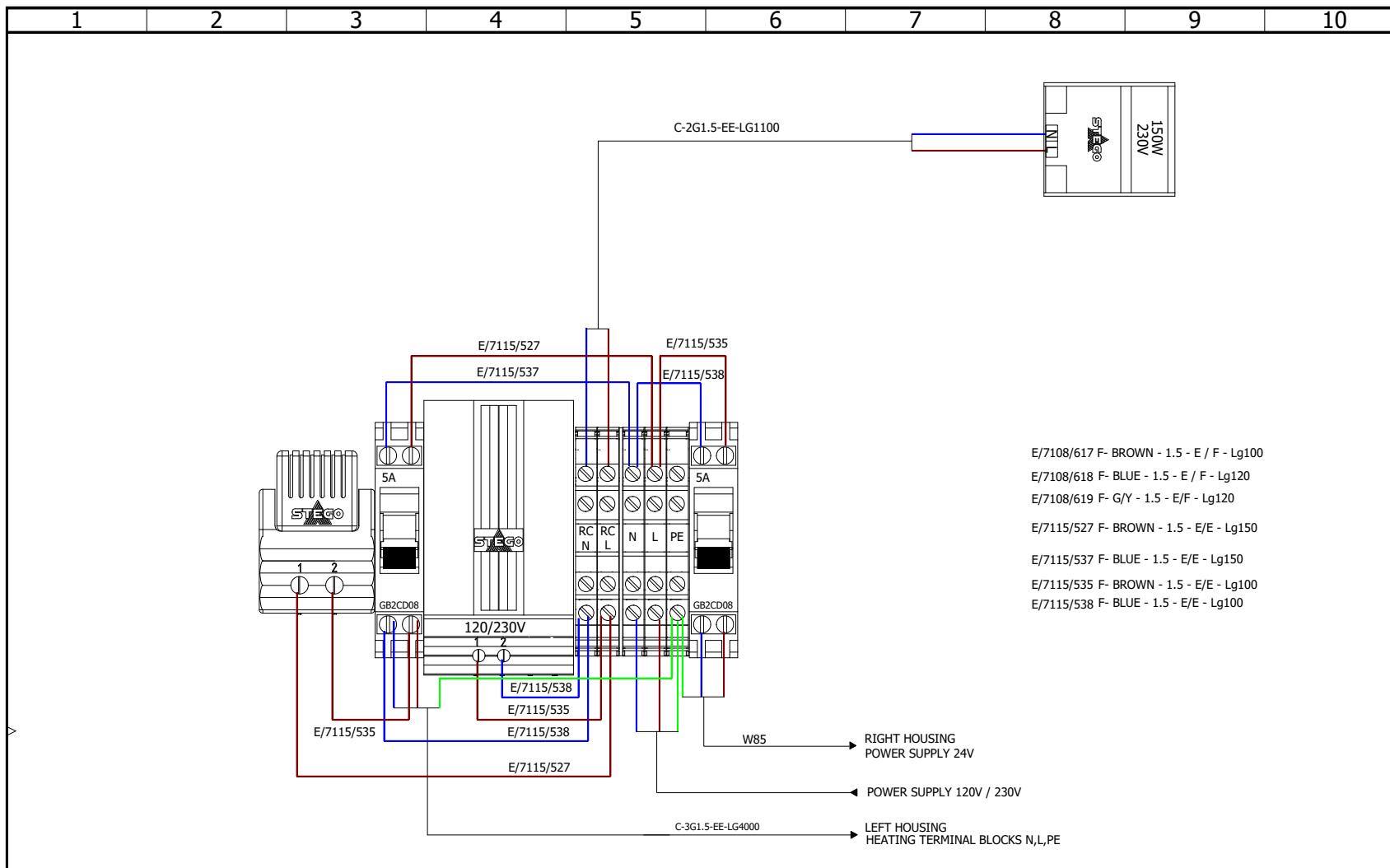

- E/7108/617 F- BROWN - 1.5 - E / F - Lg100
- E/7108/618 F- BLUE - 1.5 - E / F - Lg120
- E/7108/619 F- G/Y - 1.5 - E/F - Lg120
- E/7115/527 F- BROWN - 1.5 - E/E - Lg150
- E/7115/537 F- BLUE - 1.5 - E/E - Lg150
- E/7115/535 F- BROWN - 1.5 - E/E - Lg100
- E/7115/538 F- BLUE - 1.5 - E/E - Lg100

	HEATING OPTION 120V / 230V			REVISION			
				4			
CONTRACT:	LOCATION:	FIRSTLANE V3 EU RIGHT HOUSING	REV.	DATE	NAME	CHANGES	SCHEME
			1	17-04-24	vroze		7

Document realized with version :2021.0.5.7

FIRSLANE FL9X3 - GLASS SWING GATES

ENGLISH

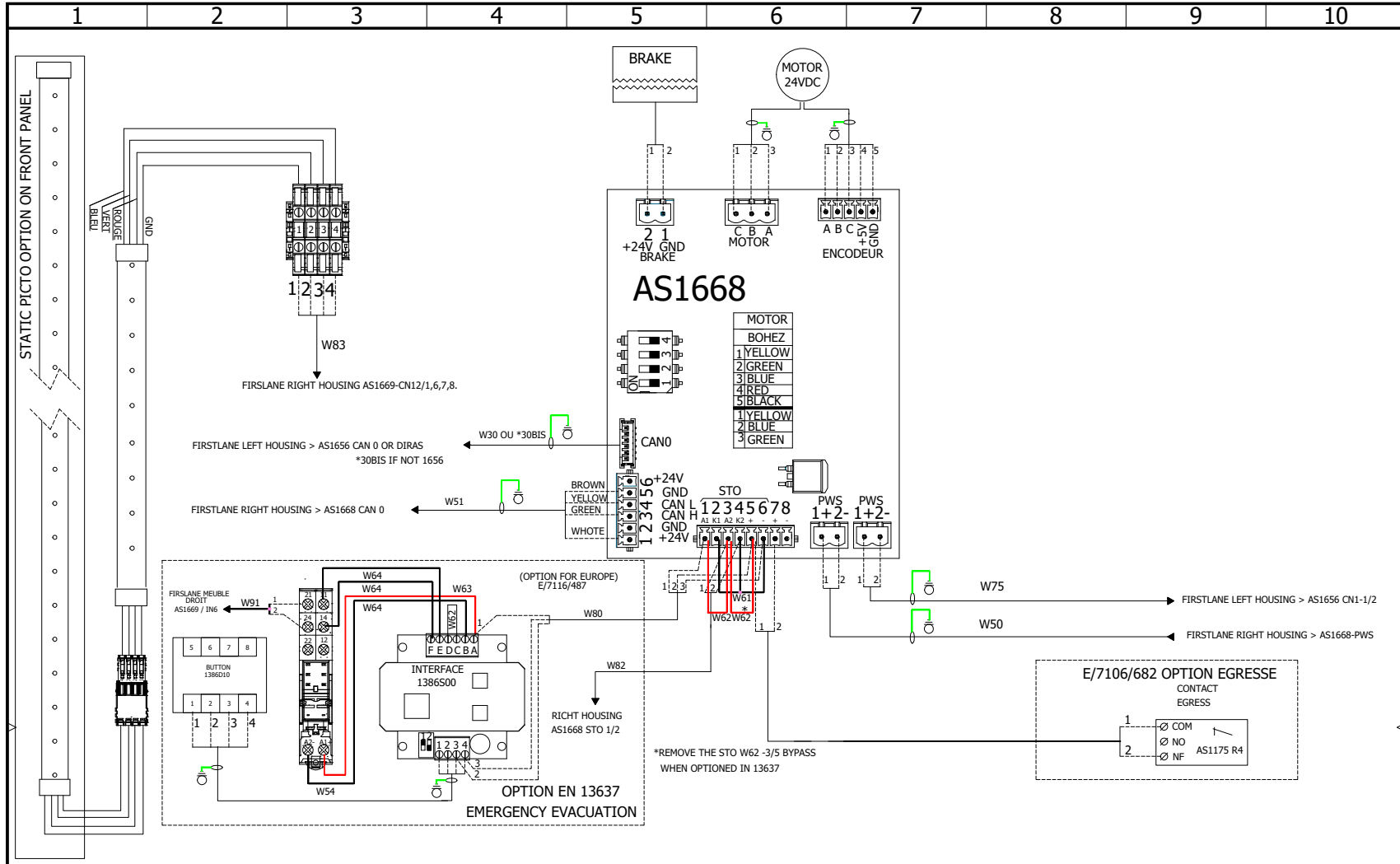

AS1668

CONTRACT:

LOCATION:

FIRSLANE V3 EU LEFT HOUSING

REV.	DATE	NAME	CHANGES	REVISION
1	17-04-24	wroze		3
				SCHEME
				1

FIRSTLANE FL9X3 - GLASS SWING GATES

ENGLISH

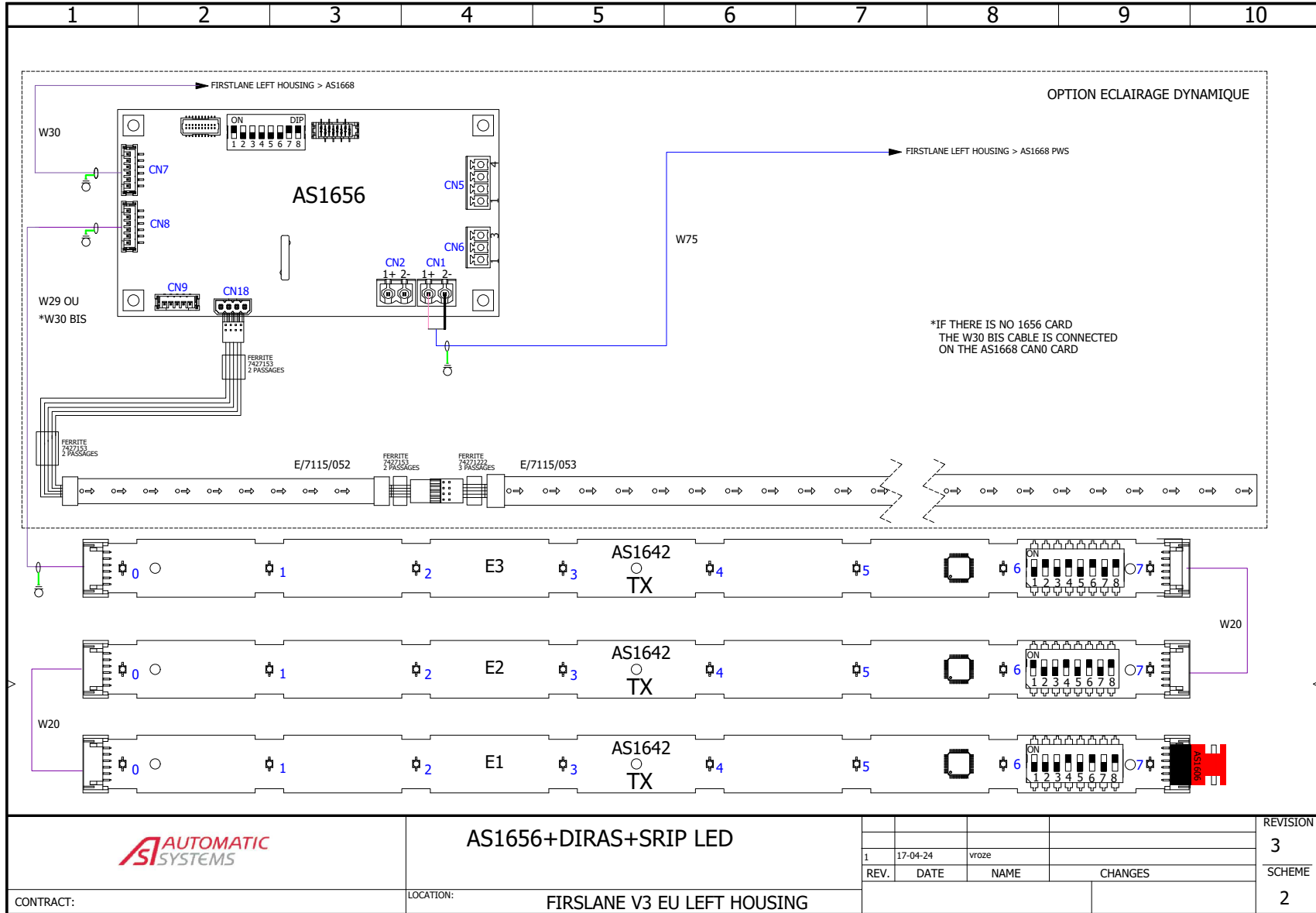

FIRSTLANE FL9X3 - GLASS SWING GATES

ENGLISH

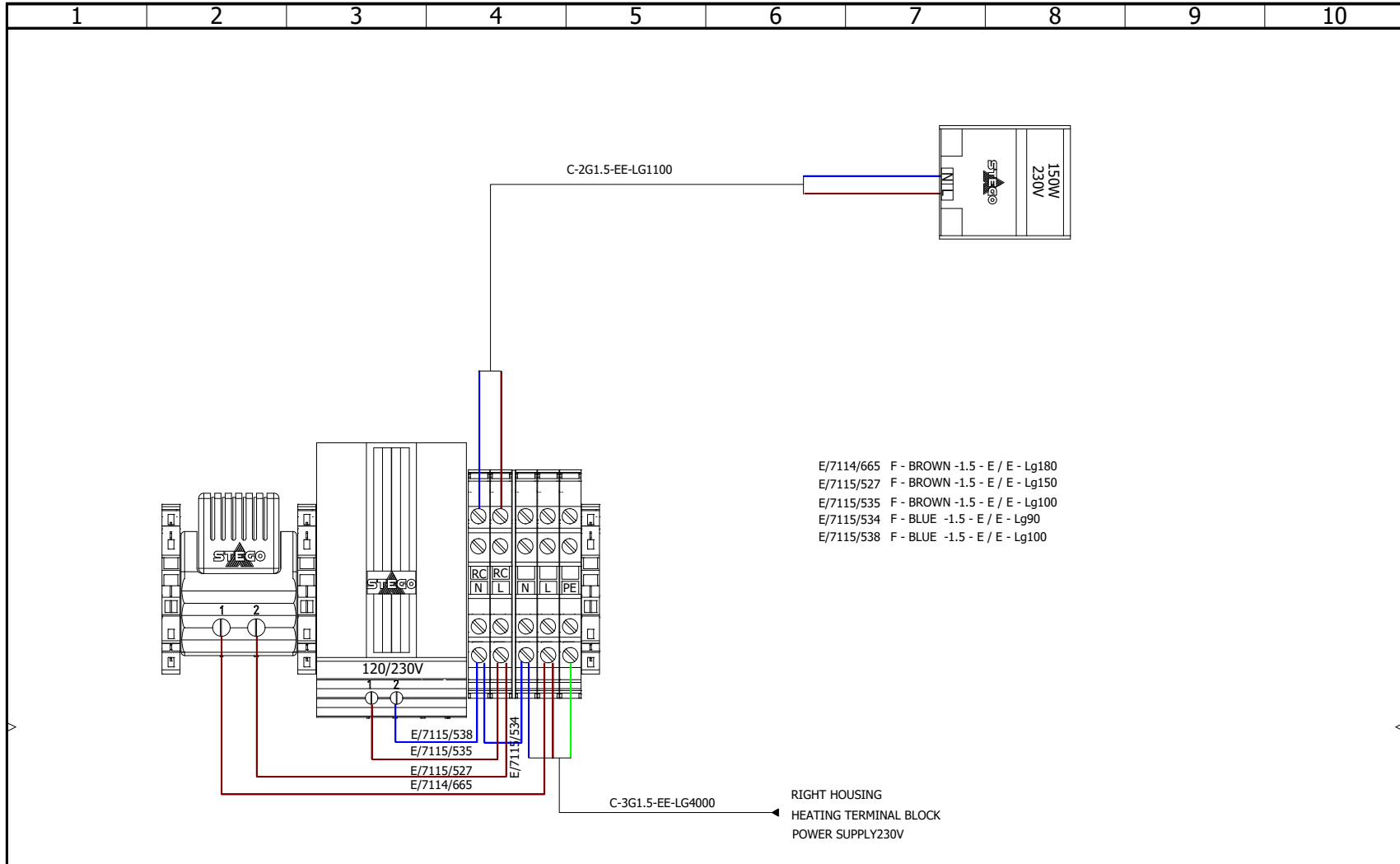

HEATING OPTION 120V / 230V

CONTRACT:

LOCATION:

FIRSLANE V3 EU LEFT HOUSING

				REVISION
				3
1	17-04-24	vroze		
REV.	DATE	NAME	CHANGES	SCHEME
				3

Document realized with version :2021.0.5.7

FIRSTLANE FL9X3 - GLASS SWING GATES

ENGLISH

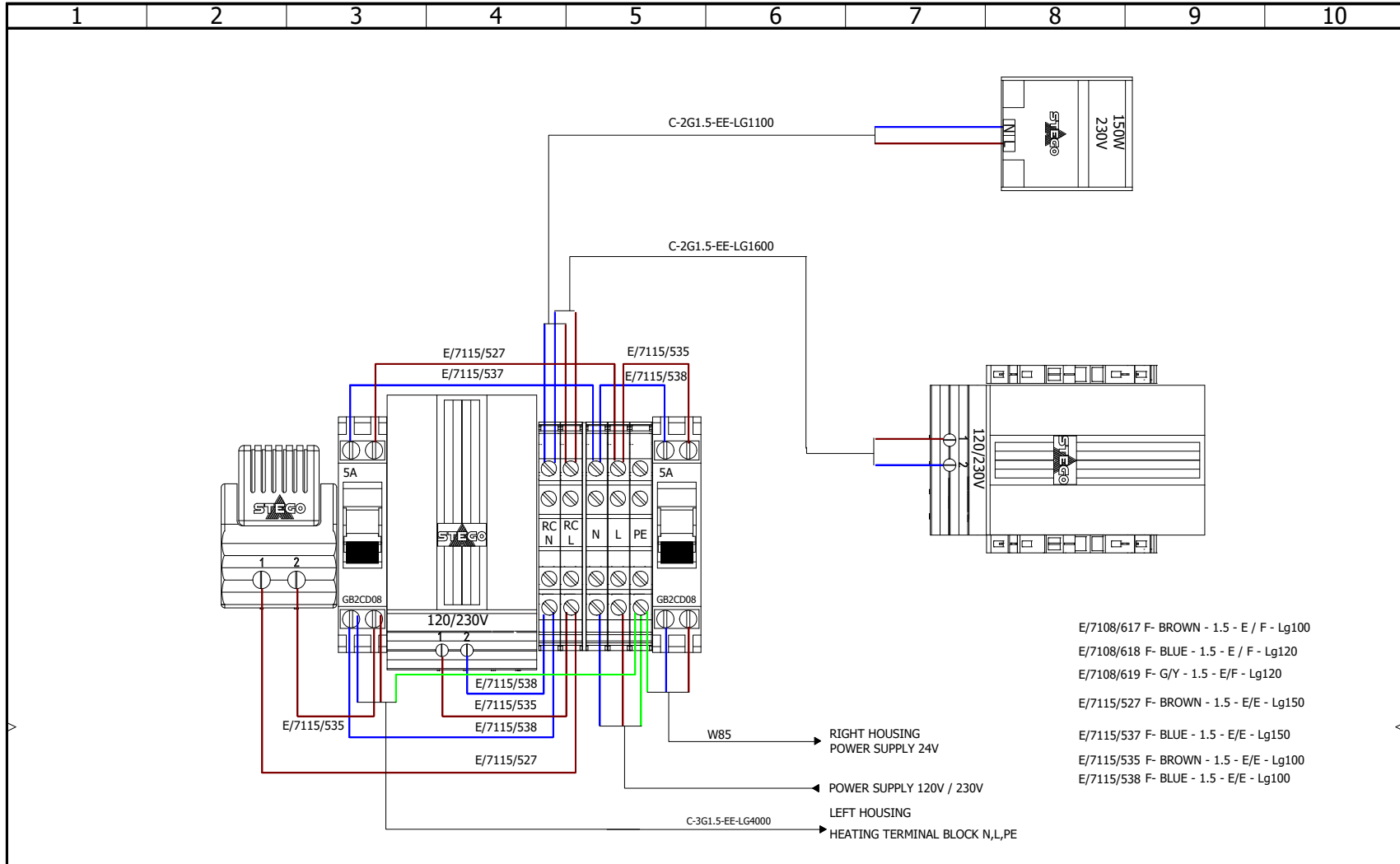

- E/7108/617 F- BROWN - 1.5 - E / F - Lg100
- E/7108/618 F- BLUE - 1.5 - E / F - Lg120
- E/7108/619 F- G/Y - 1.5 - E/F - Lg120
- E/7115/527 F- BROWN - 1.5 - E/E - Lg150
- E/7115/537 F- BLUE - 1.5 - E/E - Lg150
- E/7115/535 F- BROWN - 1.5 - E/E - Lg100
- E/7115/538 F- BLUE - 1.5 - E/E - Lg100

	HEATING OPTION 120V / 230V			REVISION
				1
CONTRACT:	LOCATION: FIRSTLANE V3 EU INTERMEDIATE HOUTING			SCHEME
				1

Document realized with version :2021.0.5.7



BUREAUX BELGES ET INTERNATIONAUX

Belgique

Tel.: +32.(0)10.23.02.11
helpdesk.as@automatic-systems.com

France

Tel.: +33 1 30 28 95 53
helpdesk.fr@automatic-systems.com

Allemagne

Tel.: +49 2303 553 4040
helpdesk.de@automatic-systems.com

Royaume-Uni

Tel.: +44 (0) 1604 654 210
helpdesk.uk@automatic-systems.com

Espagne

Tel.: +34 93 478 77 55
helpdesk.es@automatic-systems.com

États-Unis et Canada

Tel.: +1 450 659 0737
helpdesk.nam@automatic-systems.com

Autres pays

Tel.: +32.(0)10.23.02.11
helpdesk.as@automatic-systems.com

FirstLane 9x3-DTE-03



Headquarters

Avenue Mercator, 5
1300 Wavre - Belgium

www.automatic-systems.com 